

# Backyard Mighty FR-4 (PUbar 1700)

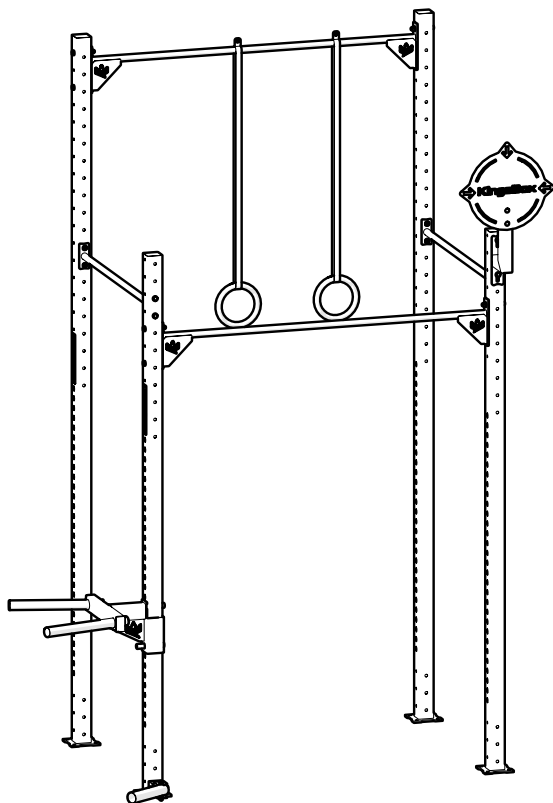

**KingsBox®**

BUILDING BETTER HUMANS

# Assembly elements:

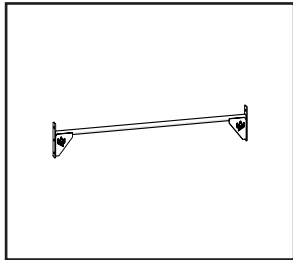

**Position 1**

PU Bar 1700 Zn

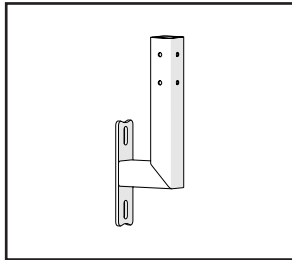

**Position 2**

WB II. Holder S Zn

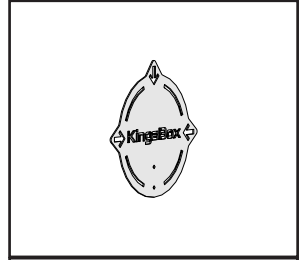

**Position 3**

WB Target III. Zn

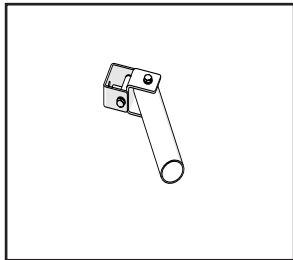

**Position 4**

Landmine Mighty for  
Rig

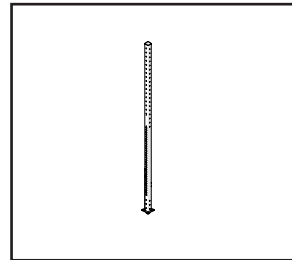

**Position 5**

Upright F 3600  
KB Zn

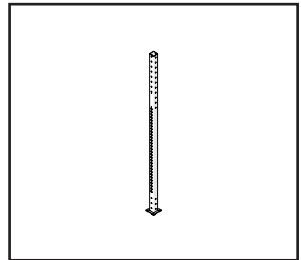

**Position 6**

Upright F 2750  
KB Zn

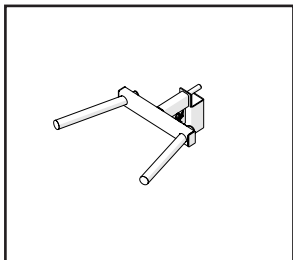

**Position 7**

Mighty Dip Bar KT

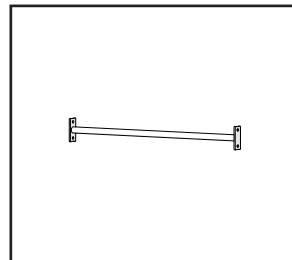

**Position 8**

PU Bar 1100 Zn

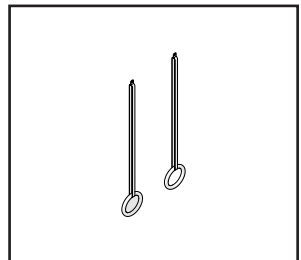

**Position 9**

Royal Wood Rings

# Assembly elements:

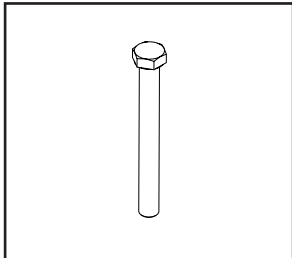

**Position 10**

**M12x110**

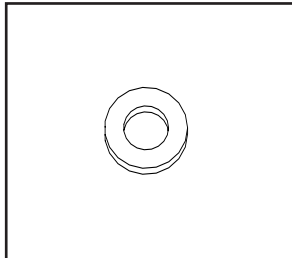

**Position 11**

**M12 Washer**

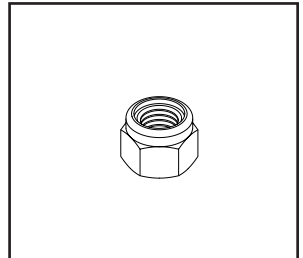

**Position 12**

**M12 Nuts**

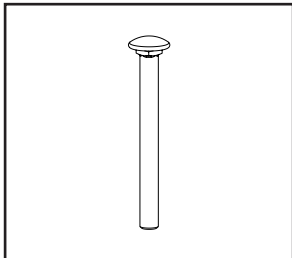

**Position 13**

**M8x80 Torban**

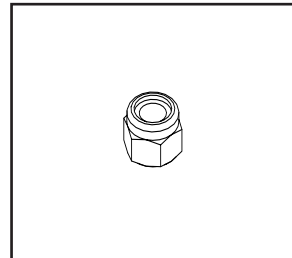

**Position 14**

**M8 Nuts**

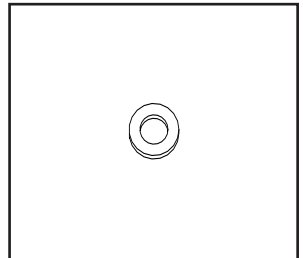

**Position 15**

**M8 Washer**

# Assembly instructions:

## STEP: 1

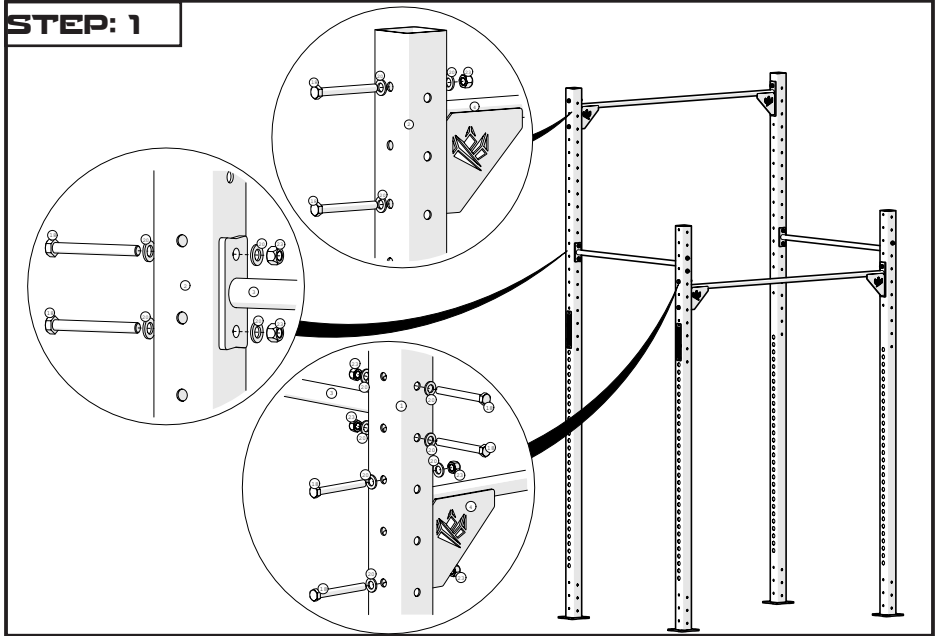

## STEP: 2

