

Mighty Outdoor Mountain

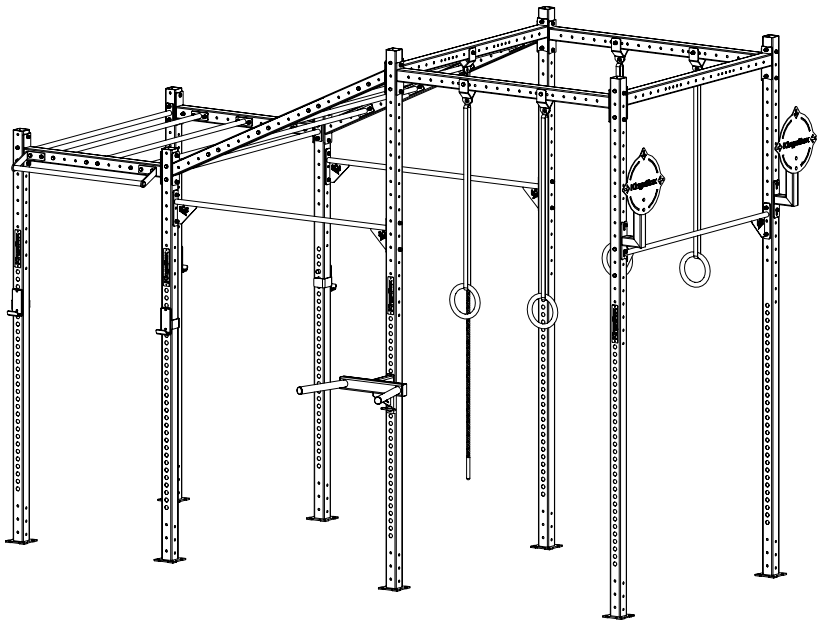

KingsBox®
BUILDING BETTER HUMANS

ATTENZIONE!

Se la struttura non viene fissata a terra e/o al muro, può rib-altarsi e/o provocare danni a persone o oggetti in immediata vicinanza.

I bulloni per il fissaggio del rig a muro e/o al pavimento non sono inclusi nel pacco, in quanto per diversi tipi di muro e pavimentazione bisogna utilizzare diversi tipi di bulloni d'ancoraggio.

OPOZORILO!

Če se struktura prevrne, lahko pride do resnih telesnih poškodb. Da bi preprečili nevarnost, da se ta struktura prevrne, mora biti pritrjena na steno in / ali v tla.

Vijaki za pritrjevanje strukture na steno oz. tla niso priloženi, saj različne sestave zidov oz. tal zahtevajo različne vrste pritrdilnih elementov. Uporabite take, ki ustrezajo sestavi vaše stene oz. tal.

WARNING!

If the structure is not secured to the ground and / or to the wall, it may overturn and / or cause damage to person or object in the immediate vicinity.

The fixing bolts for wall and / or floor are not included in the pack-age, since different types of anchor bolts must be used for different wall / floor types.

Assembly elements:

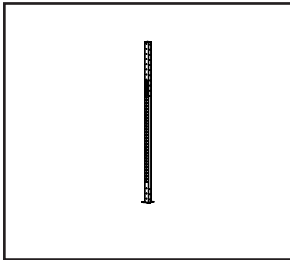

Position 1

**Upright F 2750 KB
Zn**

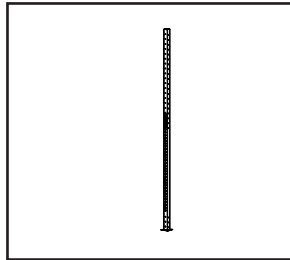

Position 2

**Upright F 3600 KB
Zn**

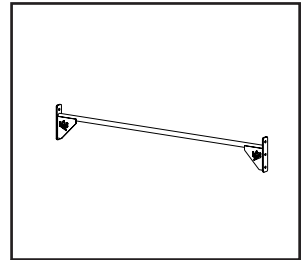

Position 3

PU Bar S 1700

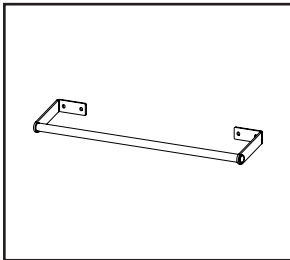

Position 4

**Monkey Mount S PU
Bar 1038**

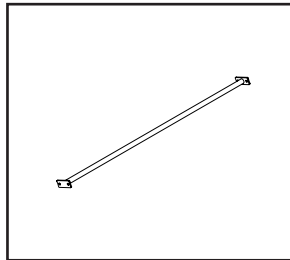

Position 5

**PU Bar Monkey S
1700 Zn**

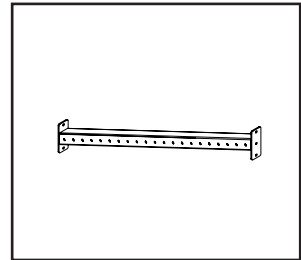

Position 6

**Monkey 65° 1700
Profile F**

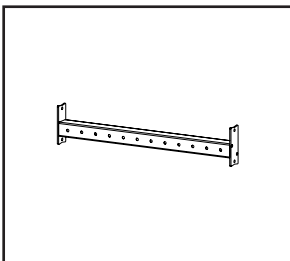

Position 7

**Universal Profile F
1100n**

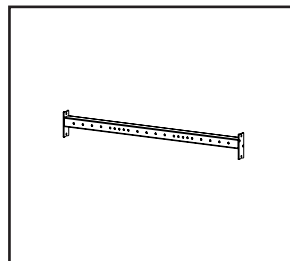

Position 8

**Universal Profile F
1700 Zn**

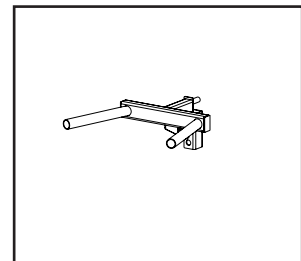

Position 9

Crown Dip Bar

Assembly elements:

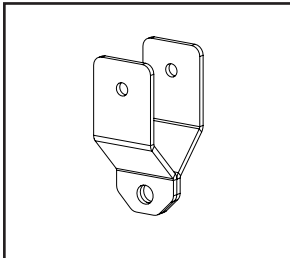

Position 10

Mighty Iron Hand

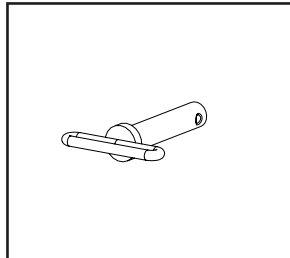

Position 11

Pin Bolt fi 25

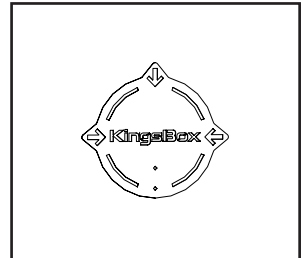

Position 12

WB Target III. Zn

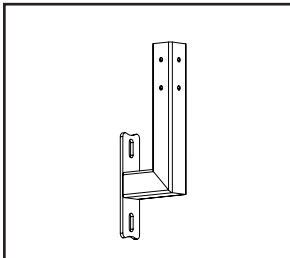

Position 13

WB Holder Zn

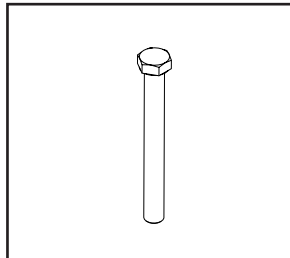

Position A

M12x110

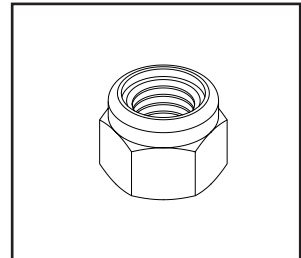

Position B

M12 Nuts

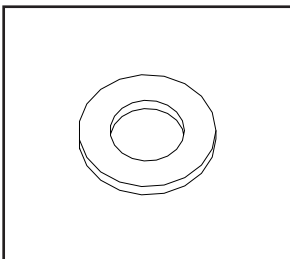

Position C

M12 Washer

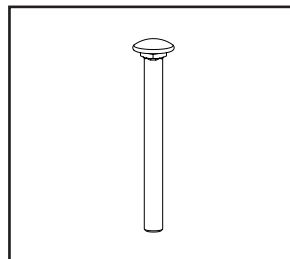

Position D

M8x80 Torban

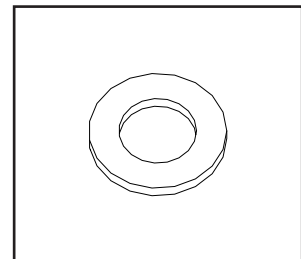

Position E

M8 Washer

Assembly elements:

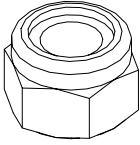

Position F

M8 Nuts



Position G

M12x120

Assembly instruction:

STEP: 1

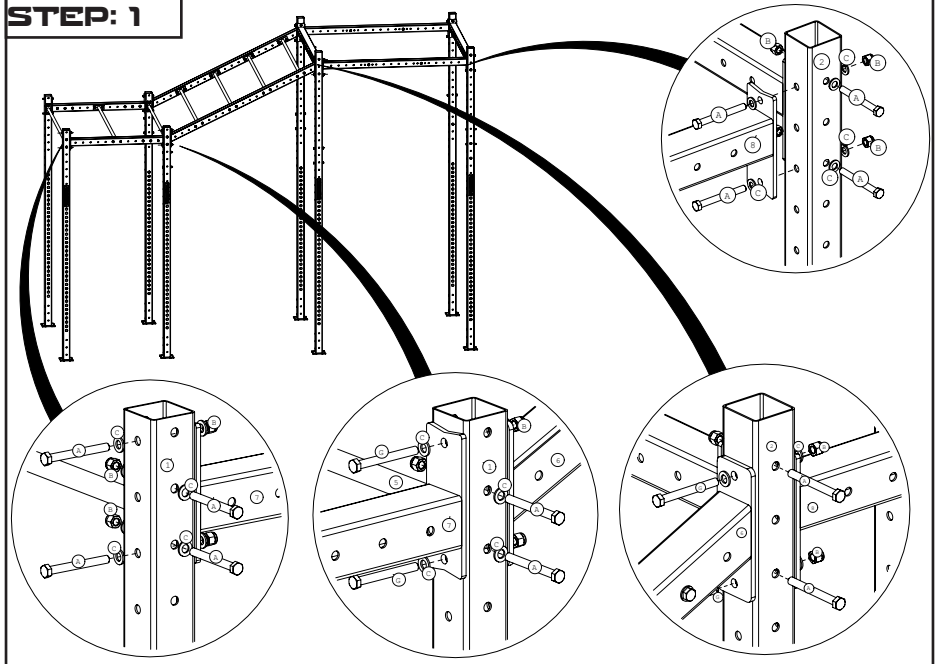

STEP: 2

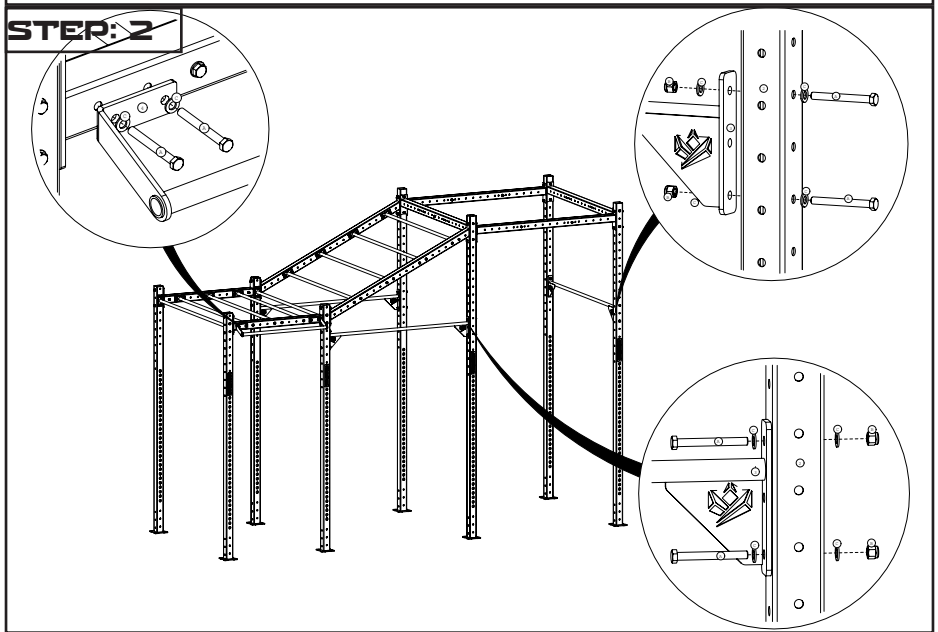

Assembly instruction:

STEP: 3

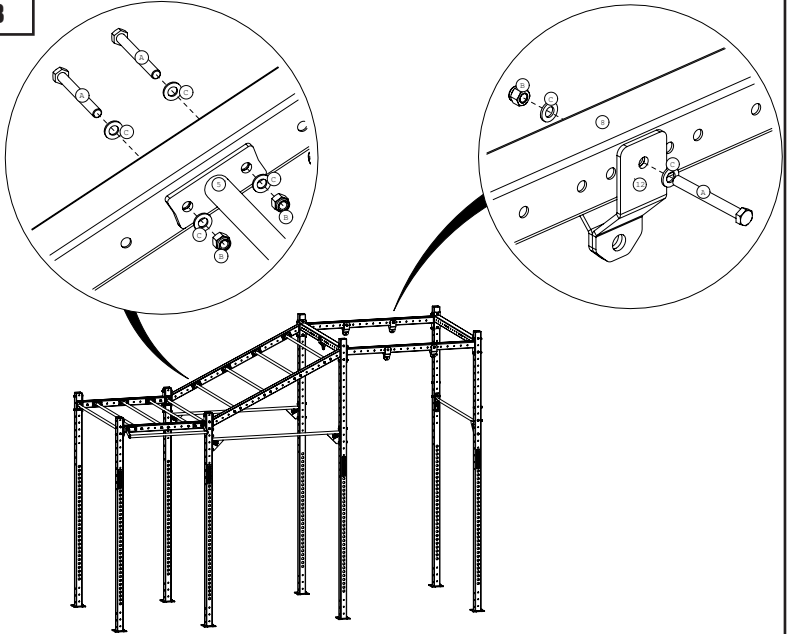

STEP: 4

