

Backyard Mighty WR-2

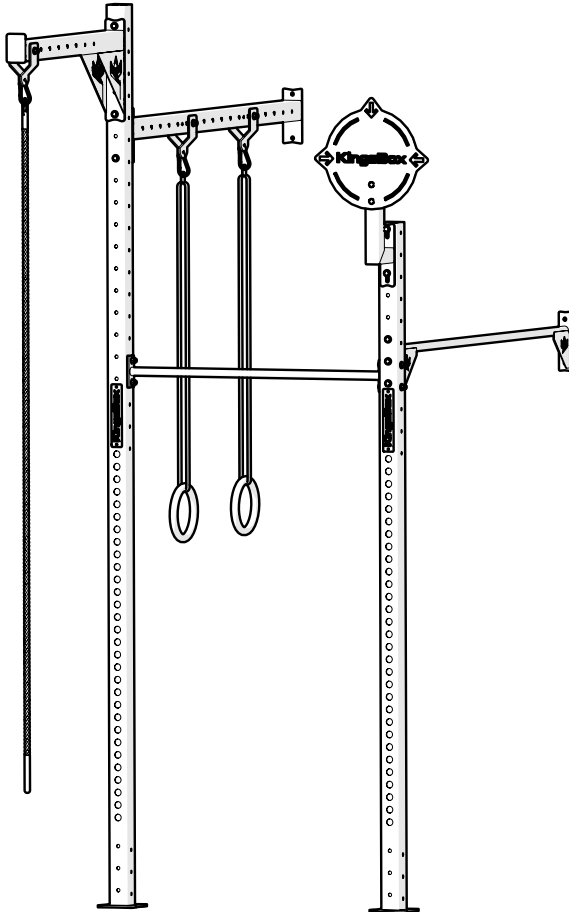

KingsBox[®]
BUILDING BETTER HUMANS

ATTENZIONE!

Se la struttura non viene fissata a terra e/o al muro, può rib-altarsi e/o provocare danni a persone o oggetti in immediata vicinanza.

I bulloni per il fissaggio del rig a muro e/o al pavimento non sono inclusi nel pacco, in quanto per diversi tipi di muro e pavimentazione bisogna utilizzare diversi tipi di bulloni d'ancoraggio.

OPOZORILO!

Če se struktura prevrne, lahko pride do resnih telesnih poškodb. Da bi preprečili nevarnost, da se ta struktura prevrne, mora biti pritrjena na steno in / ali v tla.

Vijaki za pritrjevanje strukture na steno oz. tla niso priloženi, saj različne sestave zidov oz. tal zahtevajo različne vrste pritrdilnih elementov. Uporabite take, ki ustrezajo sestavi vaše stene oz. tal.

WARNING!

If the structure is not secured to the ground and / or to the wall, it may overturn and / or cause damage to person or object in the immediate vicinity.

The fixing bolts for wall and / or floor are not included in the pack-age, since different types of anchor bolts must be used for different wall / floor types.

Assembly elements:

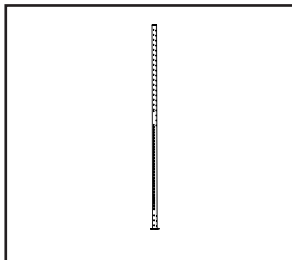

Position 1

Upright F 3600 KB
Zn

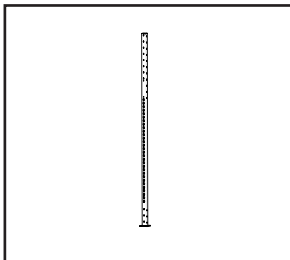

Position 2

Upright F 2750 KB
Zn

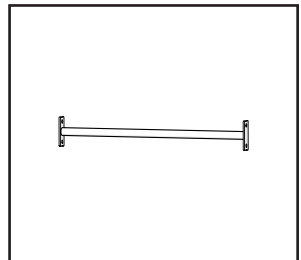

Position 3

PU Bar 1100 Zn

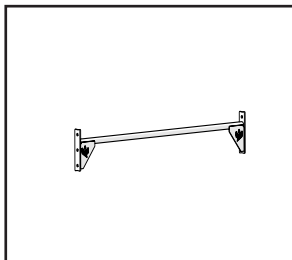

Position 4

PU Bar 1700 Zn

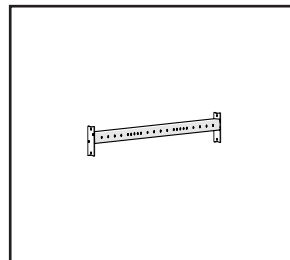

Position 5

Universal Profile F
1700 Zn

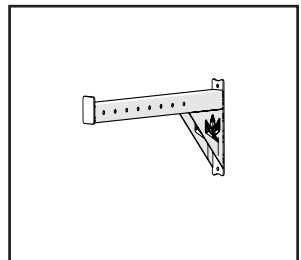

Position 6

Royal Branch F Zn

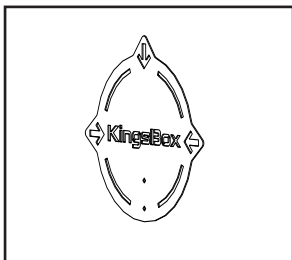

Position 7

WB Target III. Zn

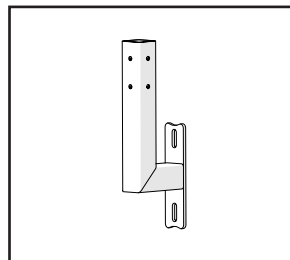

Position 8

WB II. Holder S Zn

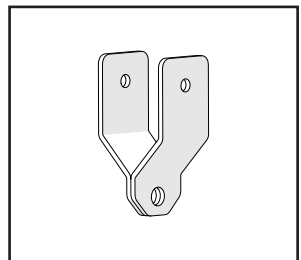

Position 9

Iron Hand Mighty

Assembly elements:

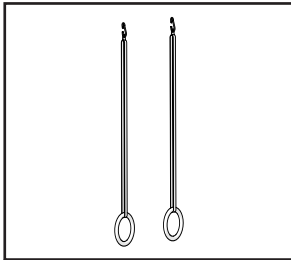

Position 10

Royal Wood Rings

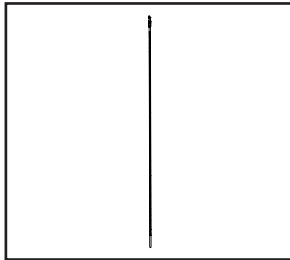

Position 11

Kings Rope

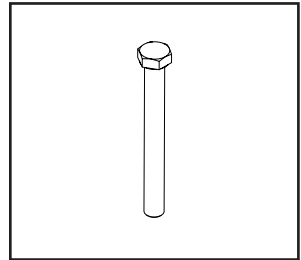

Position 12

M12x110

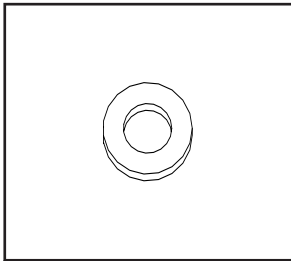

Position 13

M12 Washer

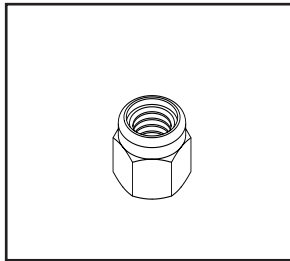

Position 14

M12 Nuts

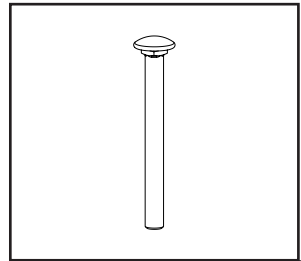

Position 15

M8x80 Torban

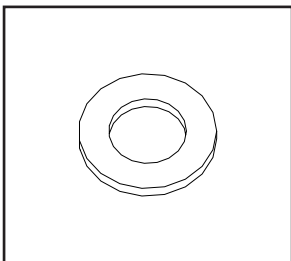

Position 16

M8 Washer

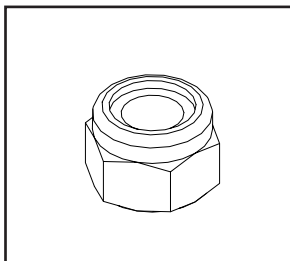

Position 17

M8 Nuts

Assembly instructions:

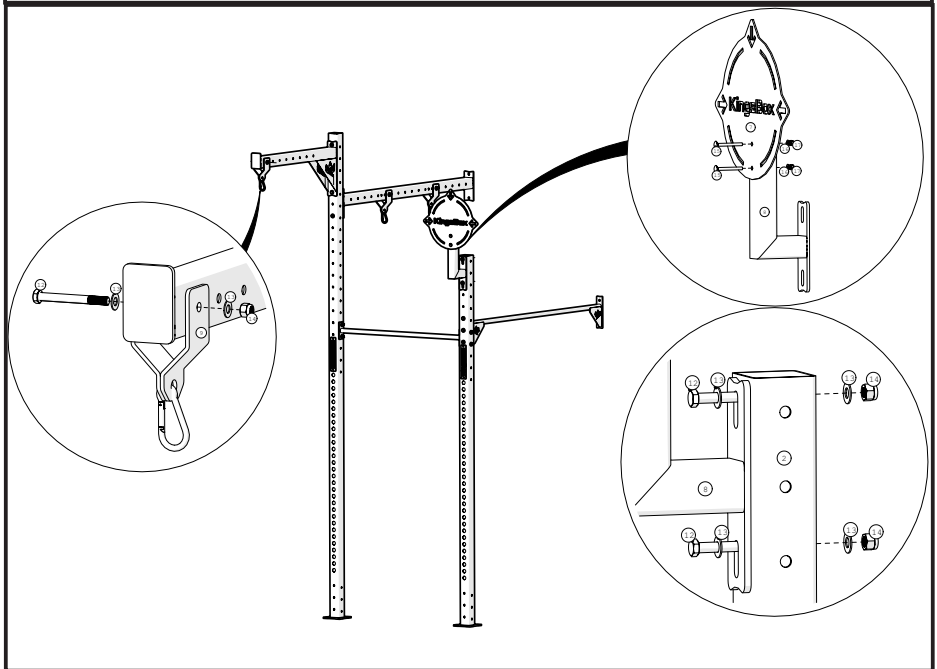
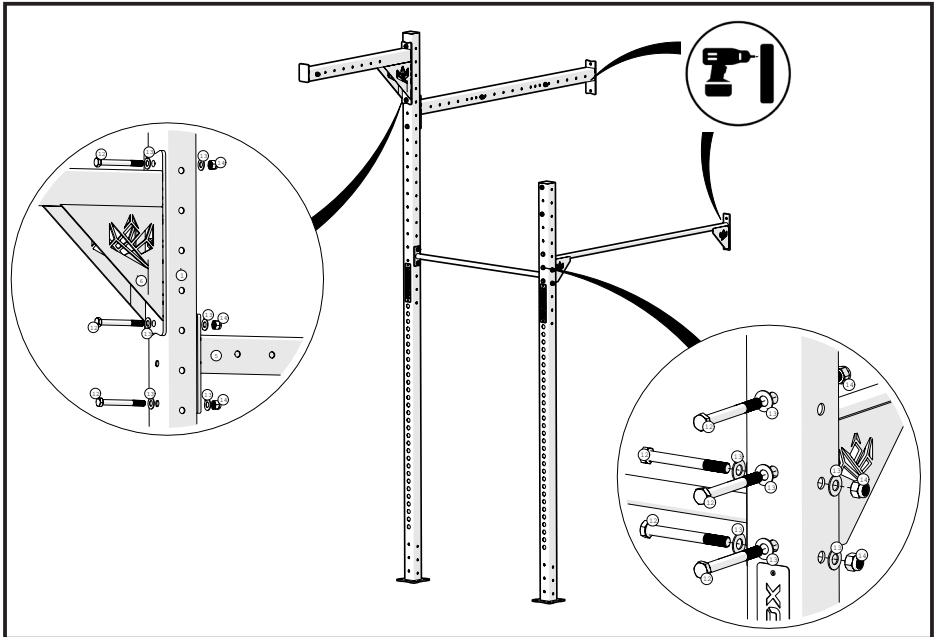

Assembly instructions:

