

# Mighty CX-35 Storage

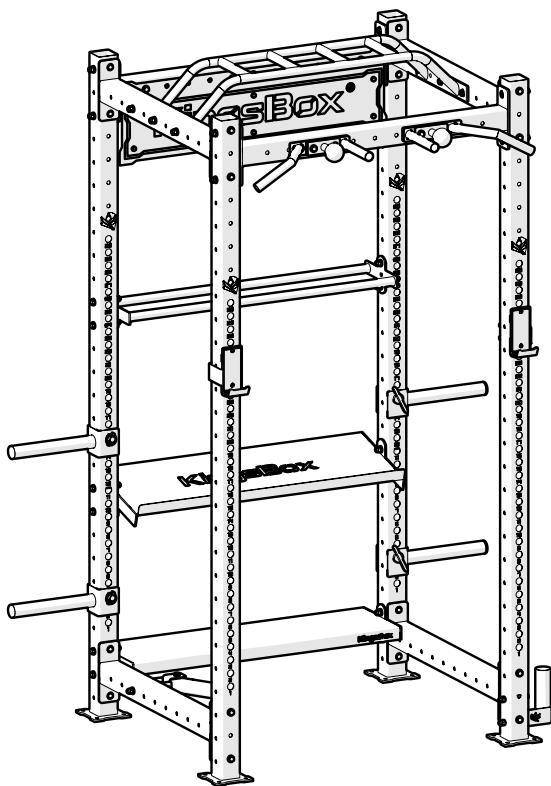

**KingsBox<sup>®</sup>**  
BUILDING BETTER HUMANS

## **ATTENZIONE!**

**Se la struttura non viene fissata a terra e/o al muro, puo' rib-altarsi e/o provocare danni a persone o oggetti in immediata vicinanza.**

I bulloni per il fissaggio del rig a muro e/o al pavimento non sono inclusi nel pacco, in quanto per diversi tipi di muro 7 pavim-entazione bisogna utilizzare diversi tipi di bulloni d'ancoraggio.

---

## **OPOZORILO!**

**Če se struktura prevrne, lahko pride do resnih telesnih poškodb. Da bi preprečili nevarnost, da se ta struktura prevrne, mora biti pritrjena na steno in / ali v tla.**

Vijaki za pritrjevanje strukture na steno oz. tla niso priloženi, saj različne sestave zidov oz. tal zahtevajo različne vrste pritrdilnih elementov. Uporabite take, ki ustrezajo sestavi vaše stene oz. tal.

---

## **WARNING!**

**If the structure is not secured to the ground and / or to the wall, it may overturn and / or cause damage to person or object in the immediate vicinity.**

The fixing bolts for wall and / or floor are not included in the pack-  
age, since different types of anchor bolts must be used for dif-  
fer-ent wall / floor types.

# Assembly elements:

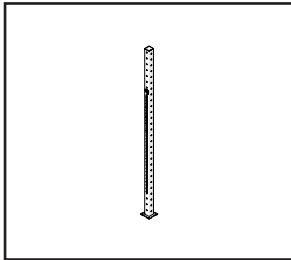

**Position: 1**

**Upright CX Mighty  
2500**

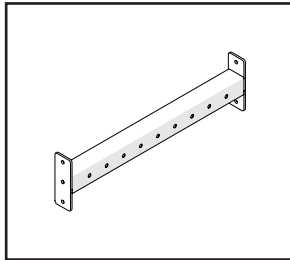

**Position: 2**

**Linked Profile 900  
F**

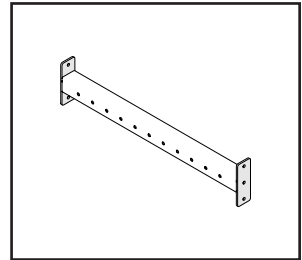

**position: 3**

**Monkey Profile 1100  
F**

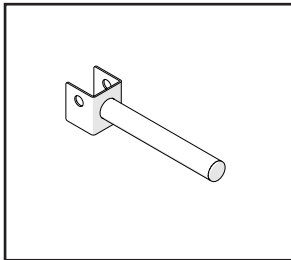

**Position: 4**

**Bumper Rack for Rig**

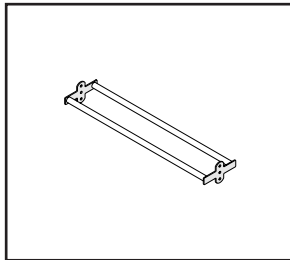

**Position: 5**

**SB Shelf 1100 88 cm**

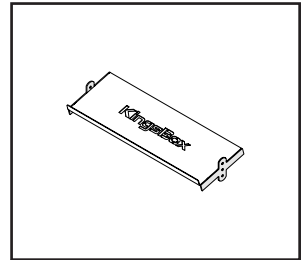

**Position: 6**

**Dumbbell Shelf 1100**

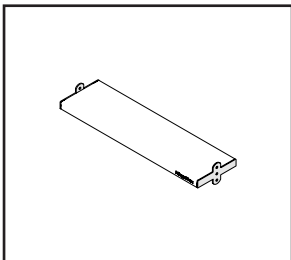

**Position: 7**

**Kettlebell Shelf 1100**

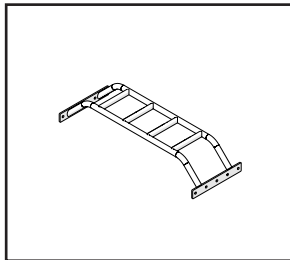

**Position: 8**

**Multi Grip PU Bar  
1100**

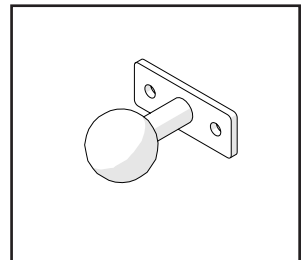

**Position: 9**

**PU 70 Sphere S**

# Assembly elements:

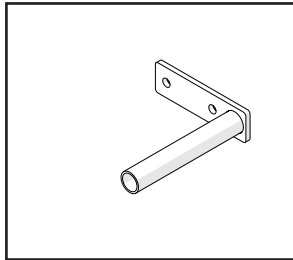

**Position: 10**

**Modular Neutral S  
Grip**

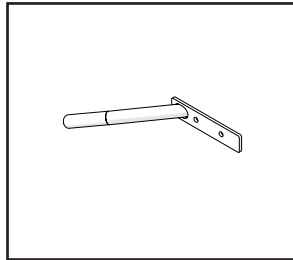

**Position: 11**

**Modular Angled S  
Grip L**

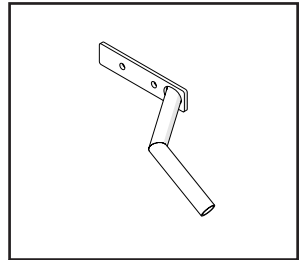

**Position: 12**

**Modular Angled S  
Grip R**

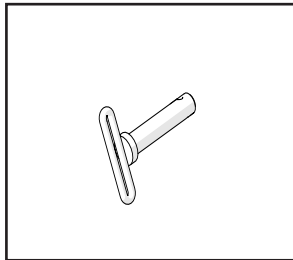

**Position: 13**

**Pin Bolt fi 25**

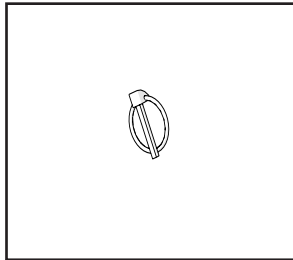

**Position: 14**

**Pinch 8mm**

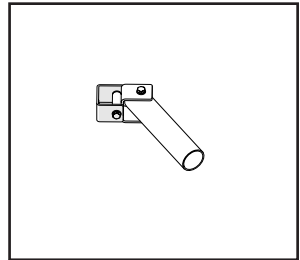

**Position: 15**

**Landmine for Rig**



**Position: 16**

**Sign Text Plate III.**

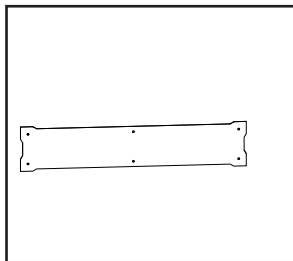

**Position: 17**

**Sign Color Plate III.**

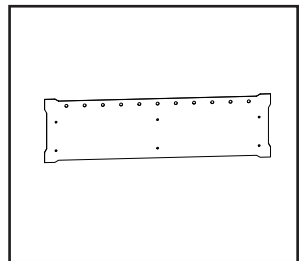

**Position: 18**

**Sign Color Plate III.**

# Assembly elements:

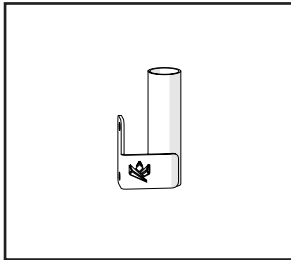

**Position: 19**

**One Bar Rack**

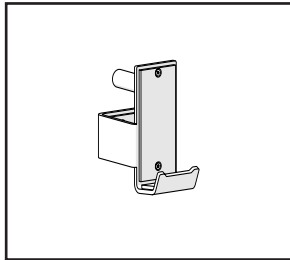

**Position: 20**

**Mighty J-Cups**

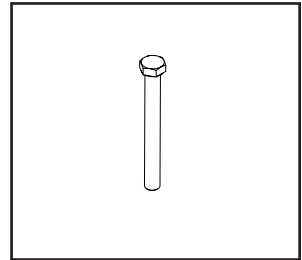

**Position: 21**

**M12x110**

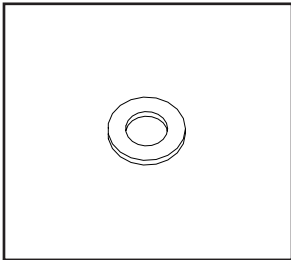

**Position: 22**

**M12 Washer**

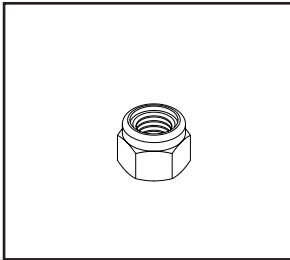

**Position: 23**

**M12 Nuts**

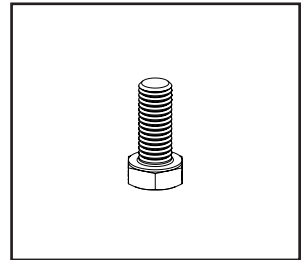

**Position: 24**

**M8x20**

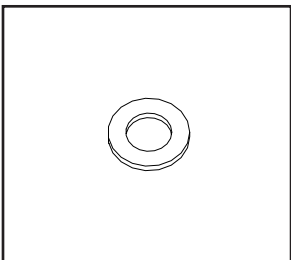

**Position: 25**

**M8 Washer**

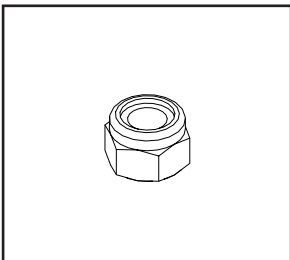

**Position: 26**

**M8 Nuts**

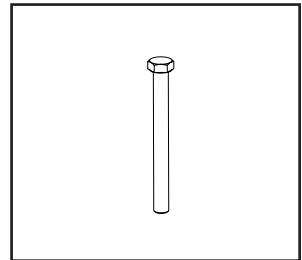

**Position: 27**

**M12x120**

# Assembly instruction:

## STEP: 1

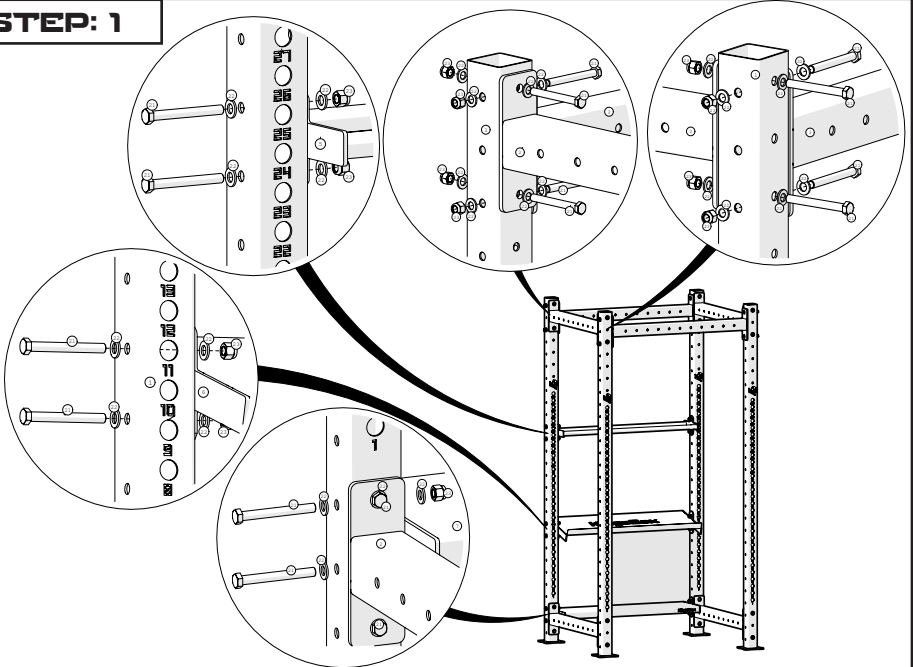

## STEP: 2

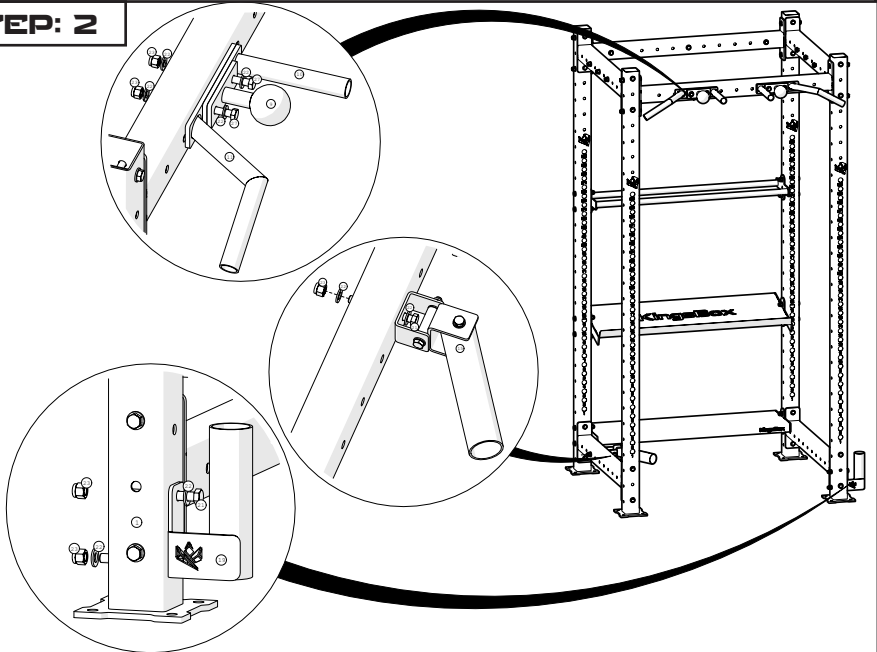

# Assembly instruction:

**STEP: 3**

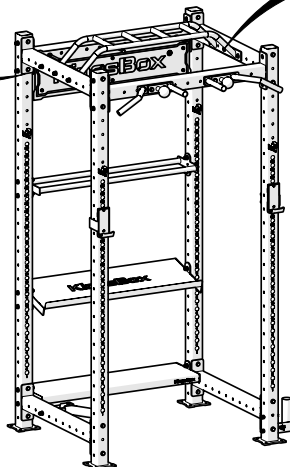
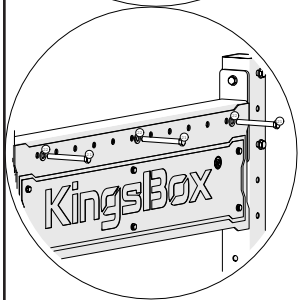
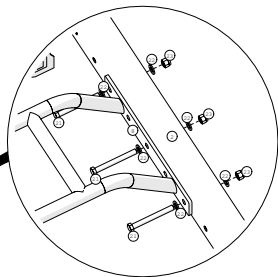
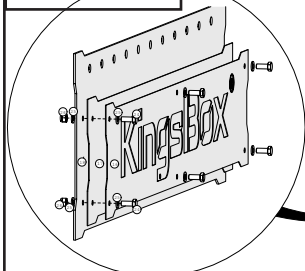

**STEP: 4**

