

Pulley Rig CX-35

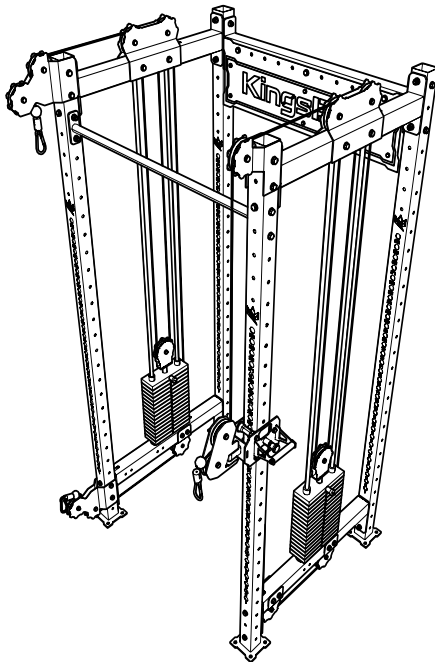

KingsBox®
BUILDING BETTER HUMANS

ATTENZIONE!

Se la struttura non viene fissata a terra e/o al muro, può rib-altarsi e/o provocare danni a persone o oggetti in immediata vicinanza.

I bulloni per il fissaggio del rig a muro e/o al pavimento non sono inclusi nel pacco, in quanto per diversi tipi di muro e pavimentazione bisogna utilizzare diversi tipi di bulloni d'ancoraggio.

OPOZORILO!

Če se struktura prevrne, lahko pride do resnih telesnih poškodb. Da bi preprečili nevarnost, da se ta struktura prevrne, mora biti pritrjena na steno in / ali v tla.

Vijaki za pritrjevanje strukture na steno oz. tla niso priloženi, saj različne sestave zidov oz. tal zahtevajo različne vrste pritrdilnih elementov. Uporabite take, ki ustrezajo sestavi vaše stene oz. tal.

WARNING!

If the structure is not secured to the ground and / or to the wall, it may overturn and / or cause damage to person or object in the immediate vicinity.

The fixing bolts for wall and / or floor are not included in the pack-age, since different types of anchor bolts must be used for different wall / floor types.

Assembly elements:

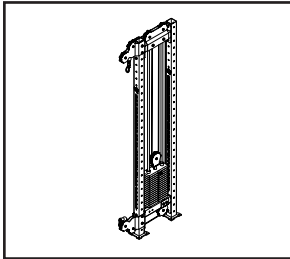

Position 1

**Static or Adjustable
Pulley Rig**

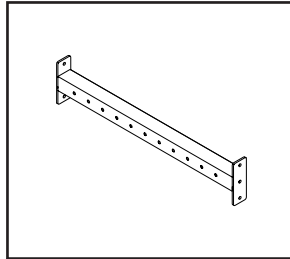

Position 2

Monkey Profile 1100

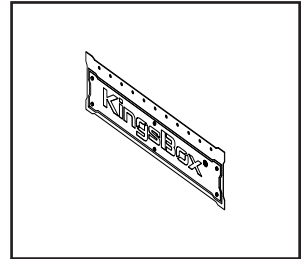

Position 3

**KingsBox Manifest
Sign**

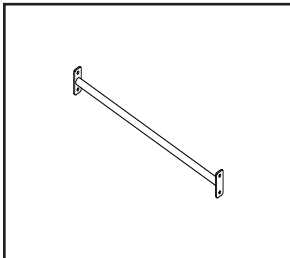

Position 4

Pull Up Bar 1100

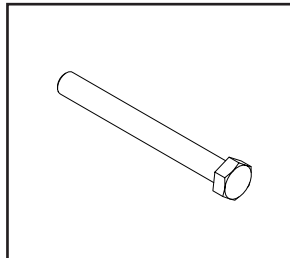

Position 6

M12x1100

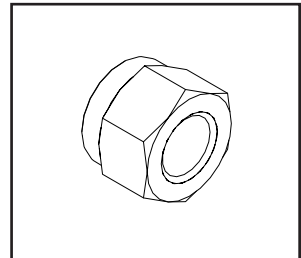

Position 7

Nut M12

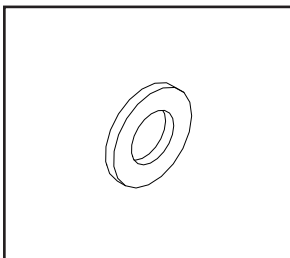

Position 8

Washer M12

Adjustable Rig Pulley 900

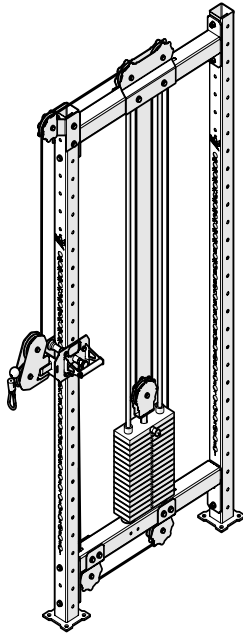

KingsBox®
BUILDING BETTER HUMANS

ATTENZIONE!

Se la struttura non viene fissata a terra e/o al muro, può rib-altarsi e/o provocare danni a persone o oggetti in immediata vicinanza.

I bulloni per il fissaggio del rig a muro e/o al pavimento non sono inclusi nel pacco, in quanto per diversi tipi di muro e pavimentazione bisogna utilizzare diversi tipi di bulloni d'ancoraggio.

OPOZORILO!

Če se struktura prevrne, lahko pride do resnih telesnih poškodb. Da bi preprečili nevarnost, da se ta struktura prevrne, mora biti pritrjena na steno in / ali v tla.

Vijaki za pritrjevanje strukture na steno oz. tla niso priloženi, saj različne sestave zidov oz. tal zahtevajo različne vrste pritrdilnih elementov. Uporabite take, ki ustrezajo sestavi vaše stene oz. tal.

WARNING!

If the structure is not secured to the ground and / or to the wall, it may overturn and / or cause damage to person or object in the immediate vicinity.

The fixing bolts for wall and / or floor are not included in the pack-age, since different types of anchor bolts must be used for different wall / floor types.

Assembly elements:

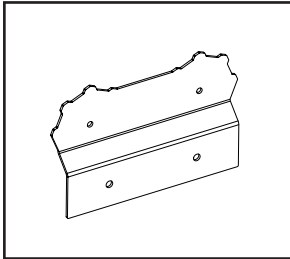

Position 1

**Pulley Rig_Static
Pulley Plate_D**

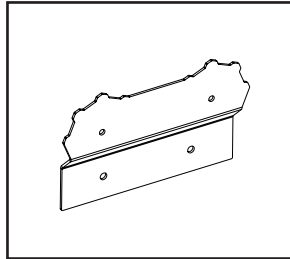

Position 2

**Pulley Rig_Static
Pulley Plate_L**

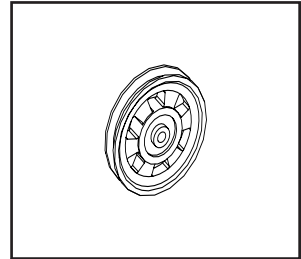

Position 3

Belt Pulley Fi 114

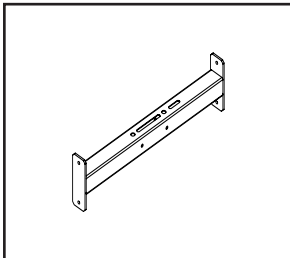

Position 4

**Pulley Rig_Connecting
Profile 900**

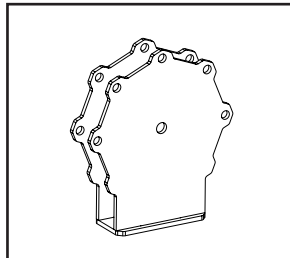

Position 5

**PT_Stack Pulley
Holder**

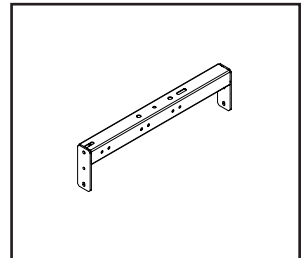

Position 6

**Pulley Rig_Connecting
Bottom 900**

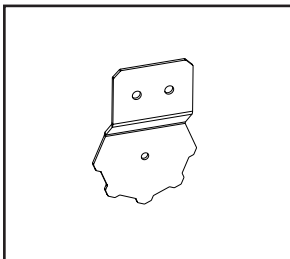

Position 7

**Pulley Rig_Static Pulley
Bottom Plate**

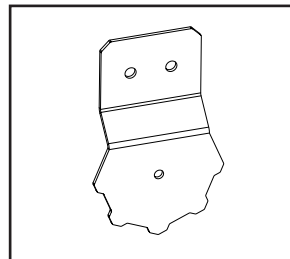

Position 8

**Pulley Rig_Static Pulley
Bottom Plate**

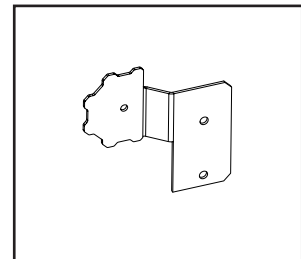

Position 9

**Pulley Rig_Single
Static Pulley_D**

Assembly elements:

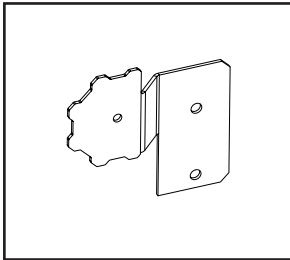

Position 10

**Pulley Rig_Single
Static Pulley_L**

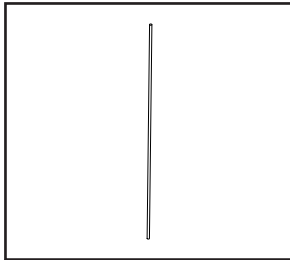

Position 11

WS_Guide Rod

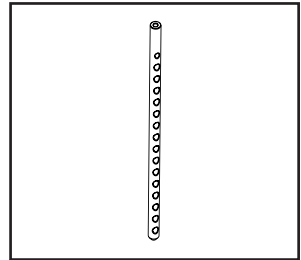

Position 12

**WS_Selector
Bar_50KG**

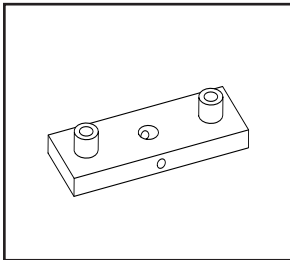

Position 13

WS-50_Top Plate

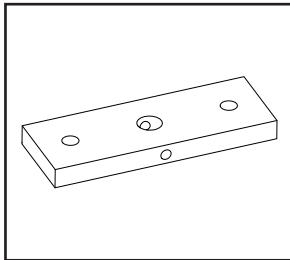

Position 14

WS-50 Weight Stack

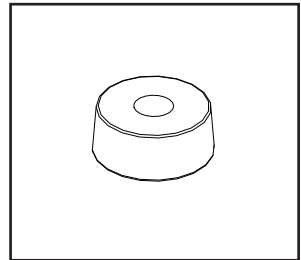

Position 15

WS_Rubber Cushion

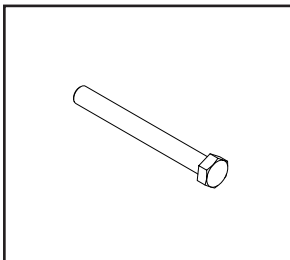

Position 16

M12x110

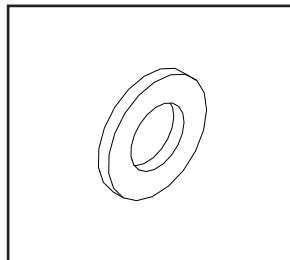

Position 17

M12 Washer

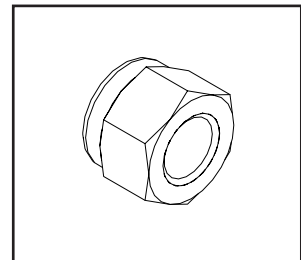

Position 18

M12 Nut

Assembly elements:

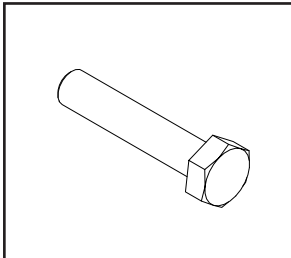

Position 19

M10x50

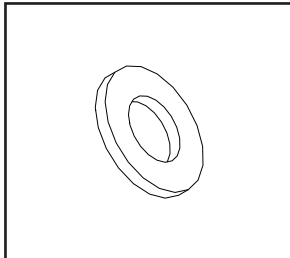

Position 20

M10 Washer

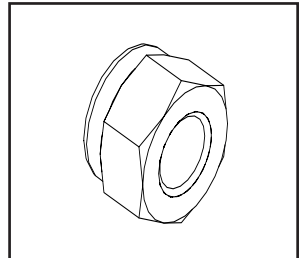

Position 21

M10 Nut

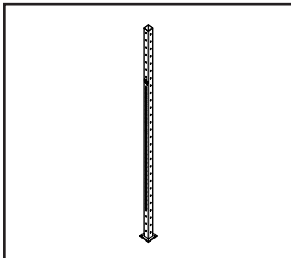

Position 22

Upright CX Mighty

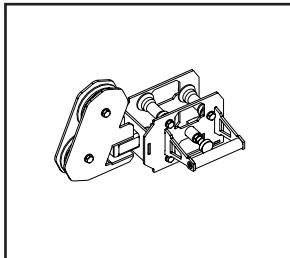

Position 23

Trolley

Assembly instruction:

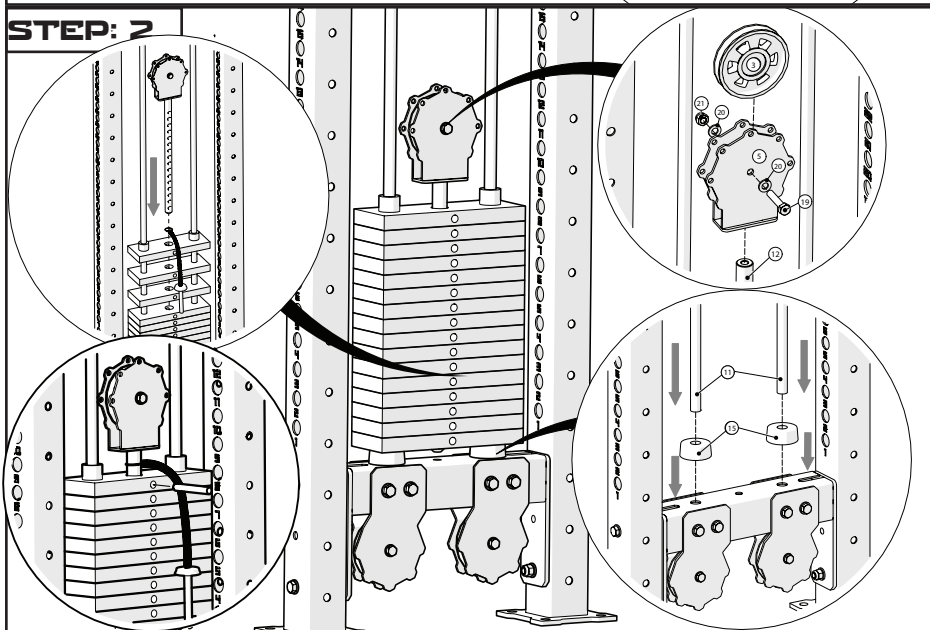
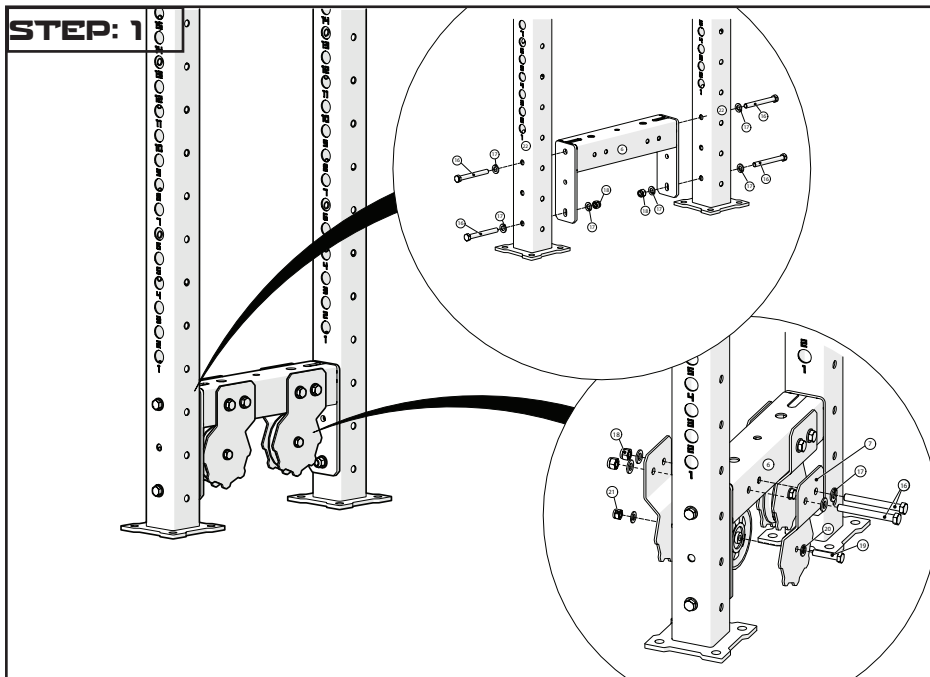

Assembly instruction:

STEP: 3

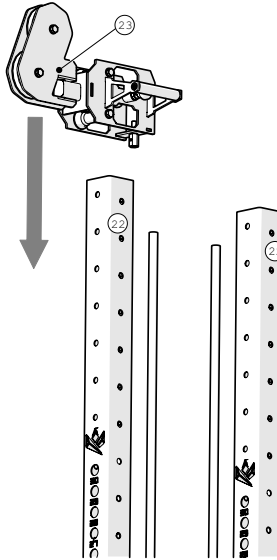

STEP: 4

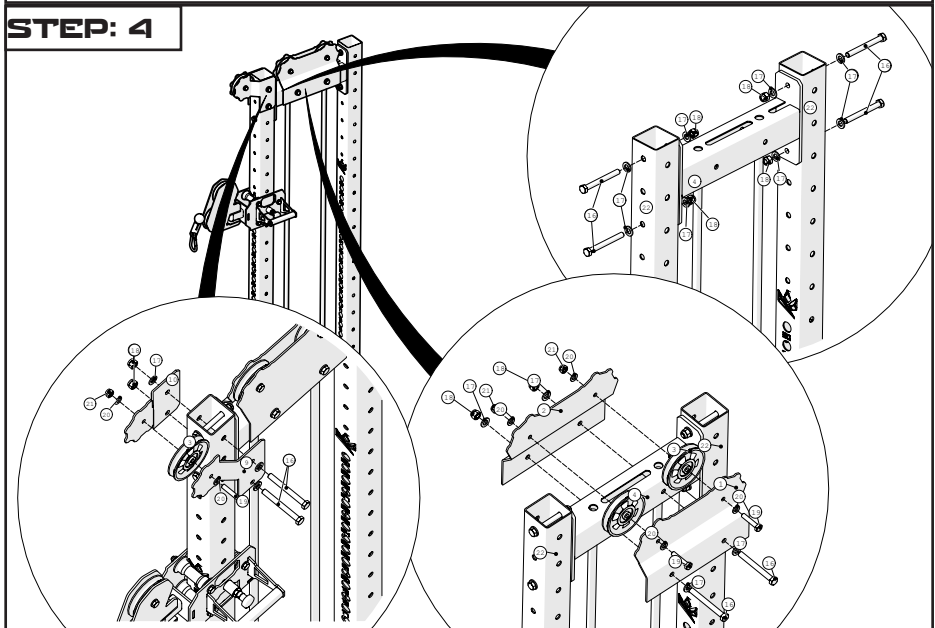

Assembly instruction:

STEP: 5

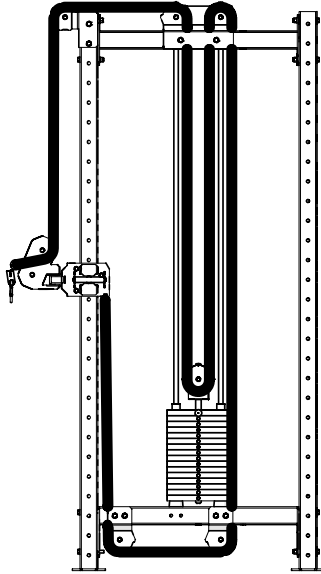

**cable
path**

Static Rig Pulley 900

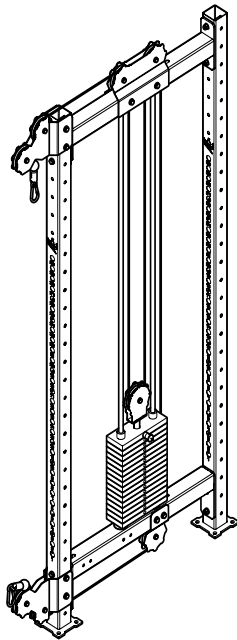

KingsBox®
BUILDING BETTER HUMANS

ATTENZIONE!

Se la struttura non viene fissata a terra e/o al muro, può rib-altarsi e/o provocare danni a persone o oggetti in immediata vicinanza.

I bulloni per il fissaggio del rig a muro e/o al pavimento non sono inclusi nel pacco, in quanto per diversi tipi di muro e pavimentazione bisogna utilizzare diversi tipi di bulloni d'ancoraggio.

OPOZORILO!

Če se struktura prevrne, lahko pride do resnih telesnih poškodb. Da bi preprečili nevarnost, da se ta struktura prevrne, mora biti pritrjena na steno in / ali v tla.

Vijaki za pritrjevanje strukture na steno oz. tla niso priloženi, saj različne sestave zidov oz. tal zahtevajo različne vrste pritrdilnih elementov. Uporabite take, ki ustrezajo sestavi vaše stene oz. tal.

WARNING!

If the structure is not secured to the ground and / or to the wall, it may overturn and / or cause damage to person or object in the immediate vicinity.

The fixing bolts for wall and / or floor are not included in the pack-age, since different types of anchor bolts must be used for different wall / floor types.

Assembly elements:

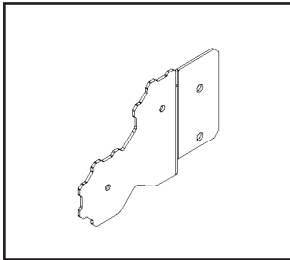

Position 1

**Pulley Rig_Static
Pulley_L**

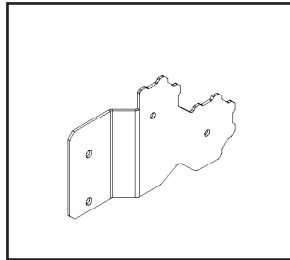

Position 2

**Pulley Rig_Static
Pulley_D**

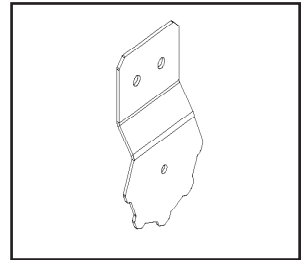

Position 3

**Pulley Rig_Static
Pulley Bottom Plate**

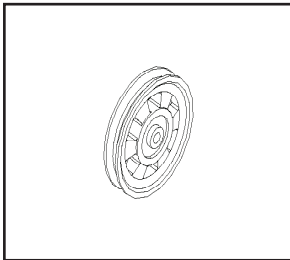

Position 4

Belt Pulley Fi 114

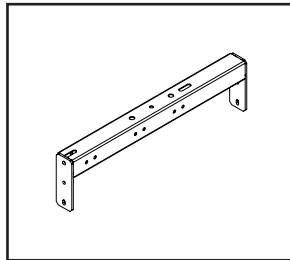

Position 5

**Pulley Rig_Connecting
Bottom 400**

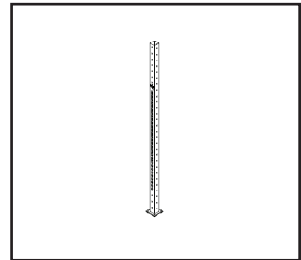

Position 6

**Upright CX Mighty
2500 v**

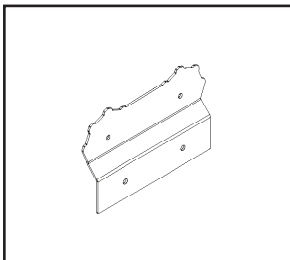

Position 7

**Pulley Rig_Static Pulley
Plate_D**

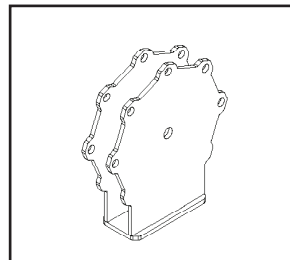

Position 8

**PT_Stack Pulley
Holder**

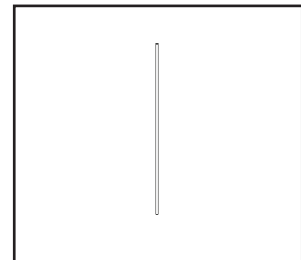

Position 9

WS_Guide Rod

Assembly elements:

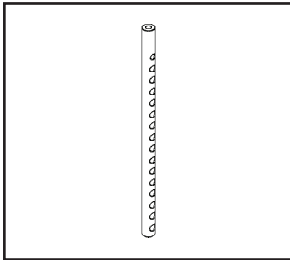

Position 10

**WS_Selector
Bar_50KG**

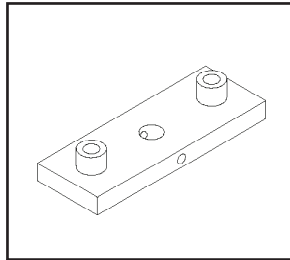

Position 11

WS-50_Top Plate

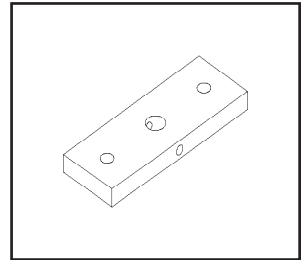

Position 12

WS-50 Weight Stack

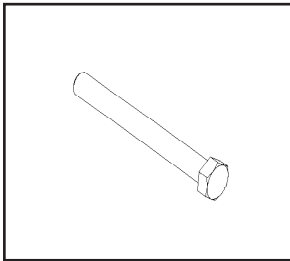

Position 13

M12x110

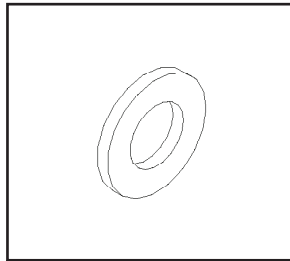

Position 14

M12 Washer

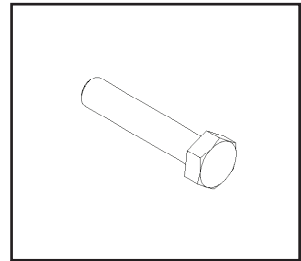

Position 15

M10x50

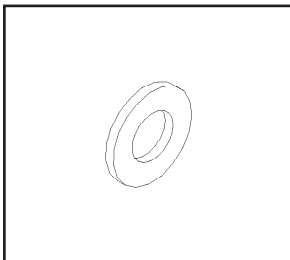

Position 16

M10 Washer

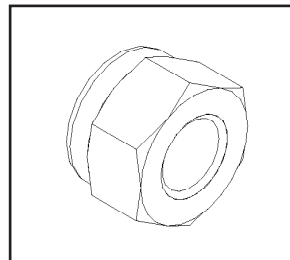

Position 17

M10 Nut

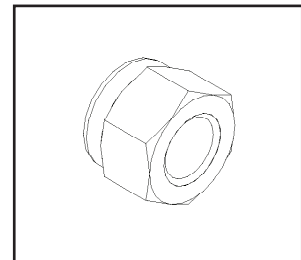

Position 18

M12 Nut

Assembly elements:

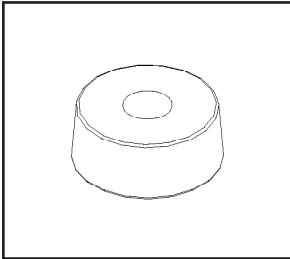

Position 19

WS_Rubber Cushion

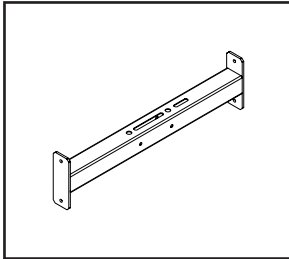

Position 20

Pulley Rig_Connecting Profile 400

Assembly instruction:

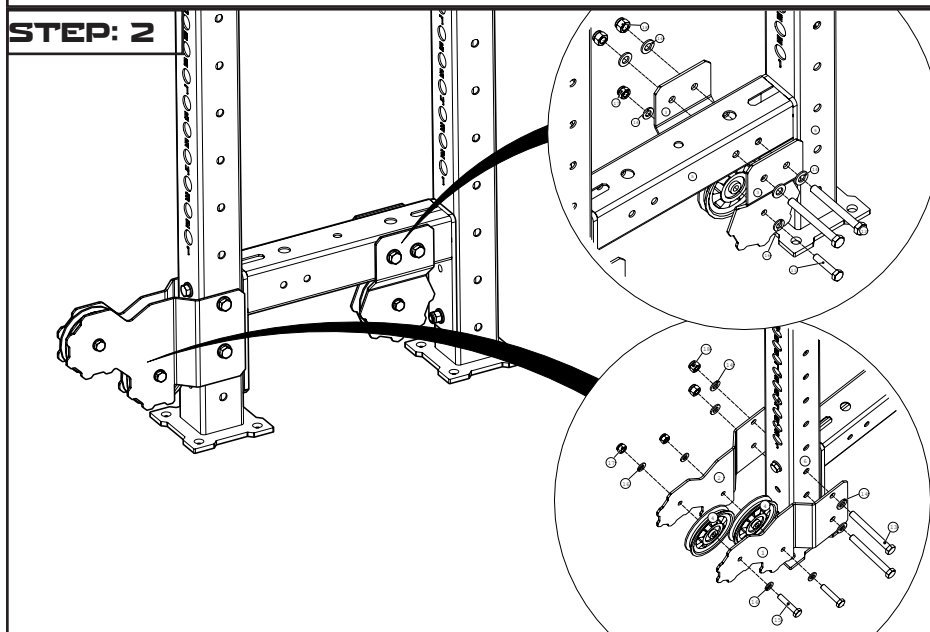
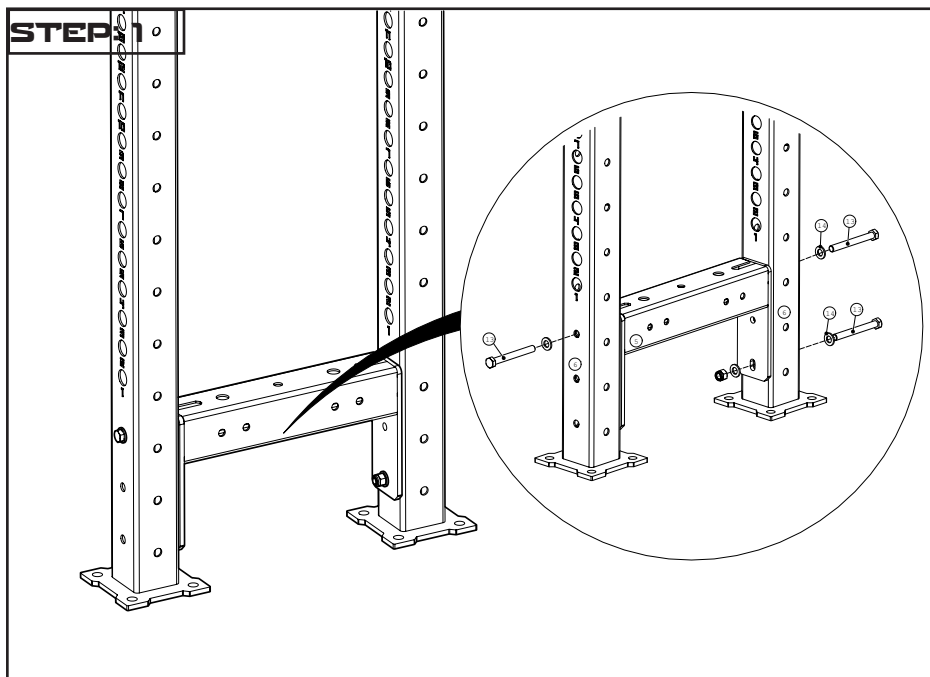

Assembly instruction:

STEP: 3

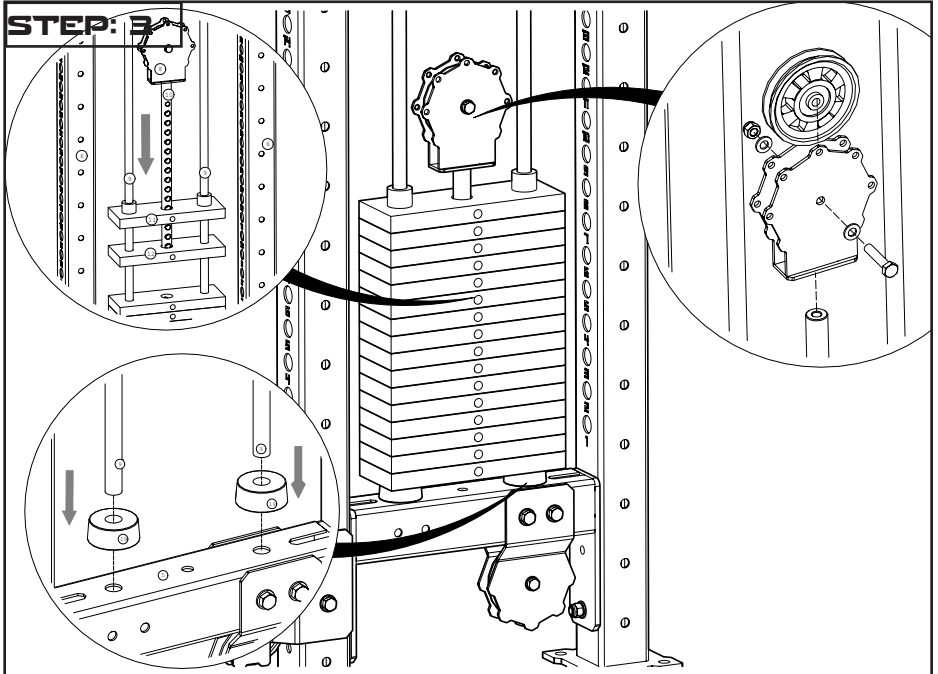

STEP: 4

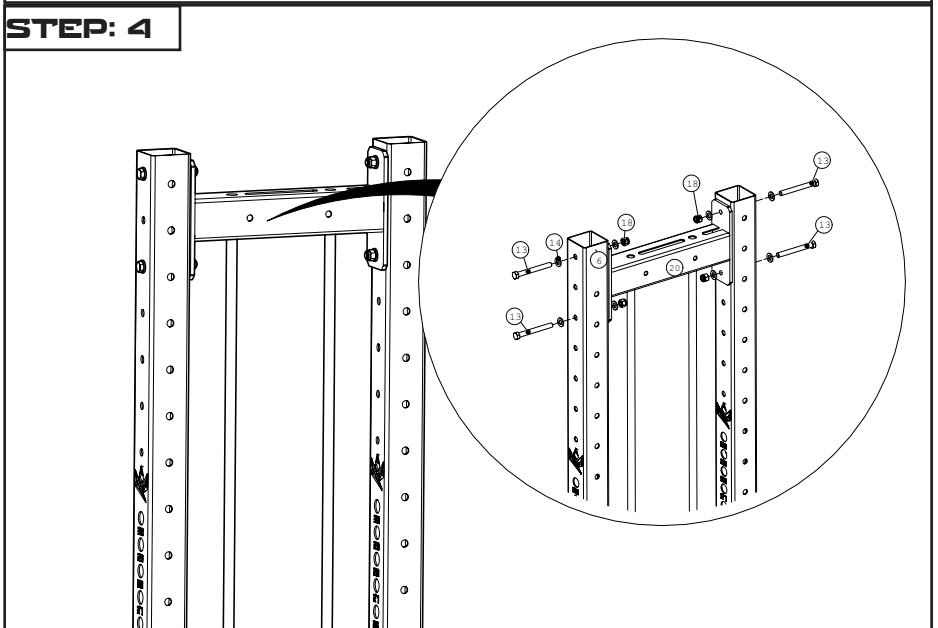

Assembly instruction:

STEP: 5

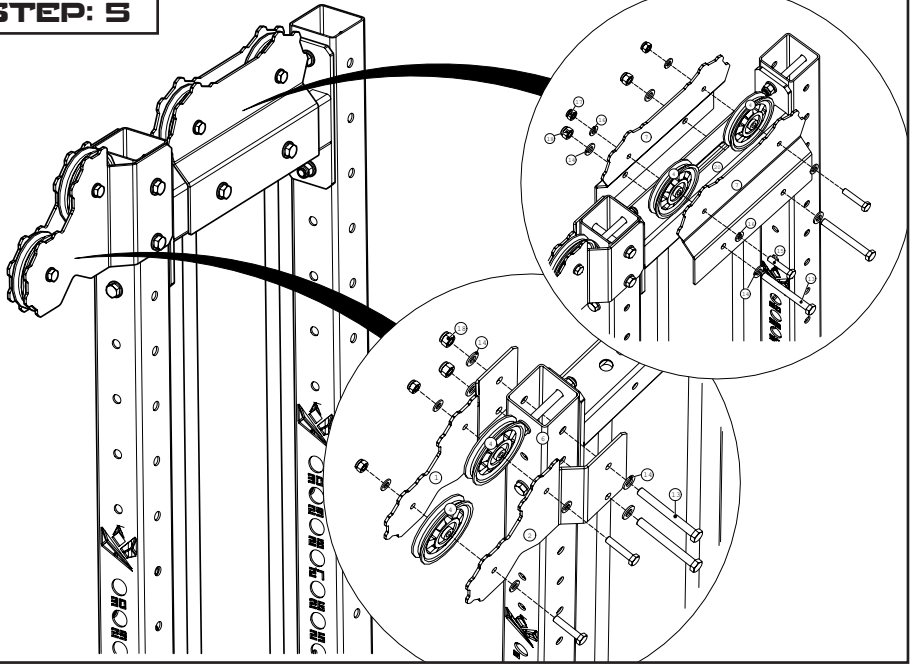

STEP: 6

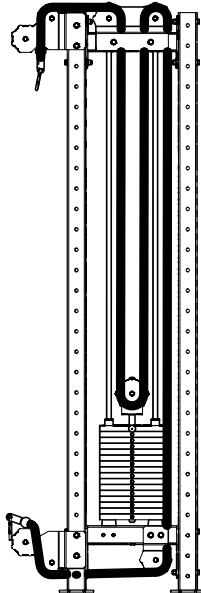

**cable
 path**

Assembly instruction:

STEP: 1

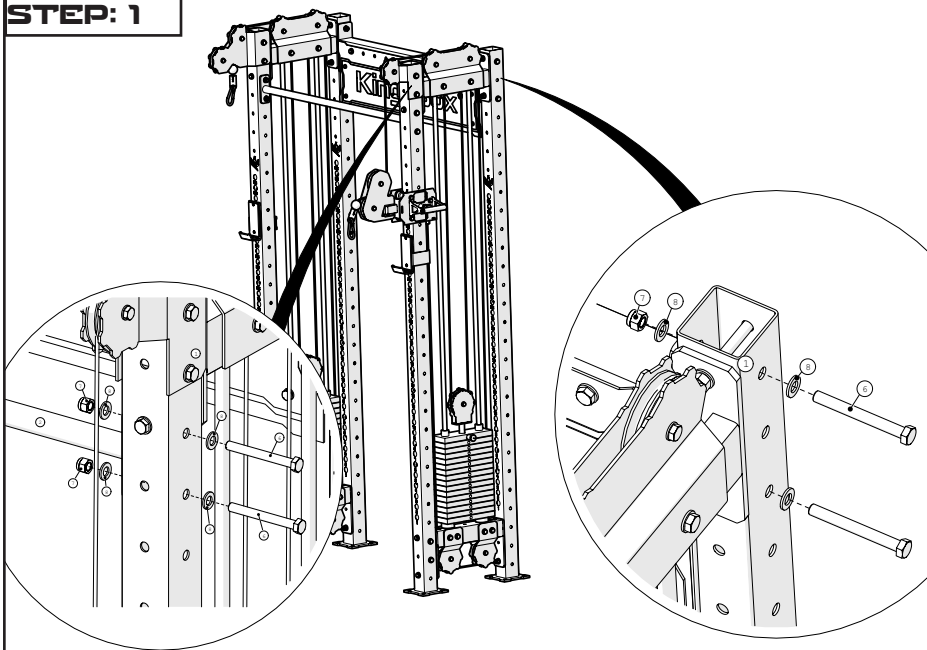

STEP: 2

