

KingsBox CX Support Legs

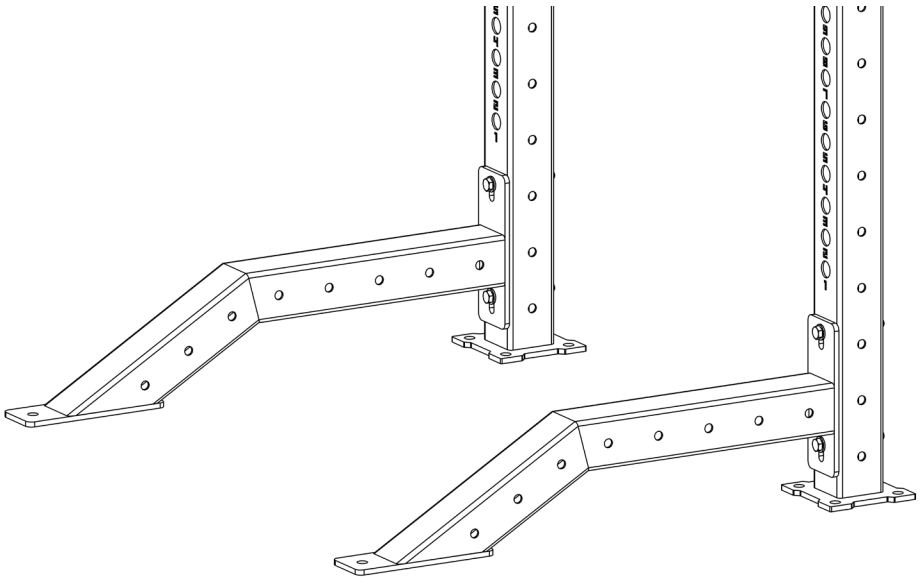

Manufacturer:
Kingsbox d.o.o.
Bazoviška 7a, 6210 Sežana
Slovenia

KingsBox®
BUILDING BETTER HUMANS

Customer service:

Write us on info@kingsbox.com or send us a message through our website at www.kingsbox.com/help

Usage class:

Studio (S)

Designed in compliance with:

ISO 20957

Warnings:

- Freestanding equipment shall be installed on a stable and levelled base
- All equipment designed with anchoring/attachement holes (e.g. rigs, racks, equipment and accessories for racks, storage pins/shelves, etc.) should be securely screwed to the fixed ground/wall/structure through all the designated fixing holes and with appropriate sized screws.
- Injuries to health may result from incorrect or excessive training
- Keep unsupervised children away from the equipment

OPOZORILO!

Če se struktura prevrne, lahko pride do resnih telesnih poškodb. Da bi preprečili nevarnost, da se ta struktura prevrne, mora biti pritrjena na steno in / ali v tla.

Vijaki za pritrjevanje strukture na steno oz. tla niso priloženi, saj r različne sestave zidov oz. tal zahtevajo različne vrste pritrdilnih elementov. Uporabite take, ki ustrezajo sestavi vaše stene oz. tal.

WARNING!

If the structure is not secured to the ground and / or to the wall, it may overturn and / or cause damage to person or object in the immediate vicinity.

The fixing bolts for wall and / or floor are not included in the package, since different types of anchor bolts must be used for different wall / floor types.

ATTENZIONE!

Se la struttura non viene fissata a terra e/o al muro, può ribaltarsi e/o provocare danni a persone o oggetti in immediata vicinanza.

I bulloni per il fissaggio del rig a muro e/o al pavimento non sono inclusi nel pacco, in quanto per diversi tipi di muro / pavimentazione bisogna utilizzare diversi tipi di bulloni d'ancoraggio.

Assembly elements:

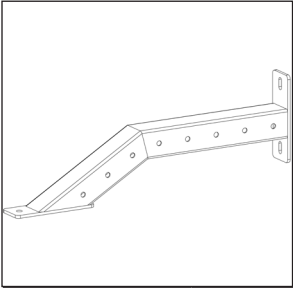

Position 1	2x
-------------------	-----------

CX Support Legs	
------------------------	--

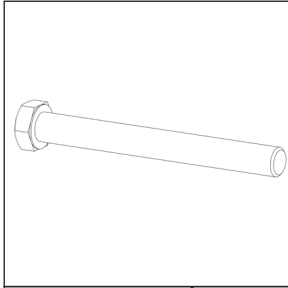

Position 2	4x
-------------------	-----------

Bolt M12	
-----------------	--

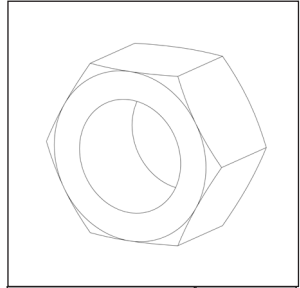

Position 3	4x
-------------------	-----------

Nut M12	
----------------	--

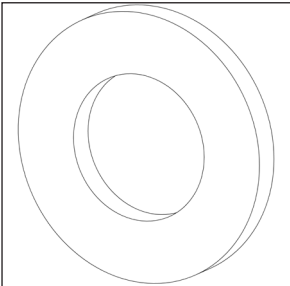

Position 4	8x
-------------------	-----------

Washer M12	
-------------------	--

Tools needed:

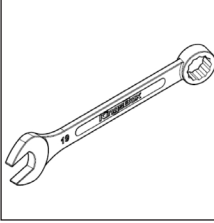

Wrench 19

2x

Assembly instruction:

1

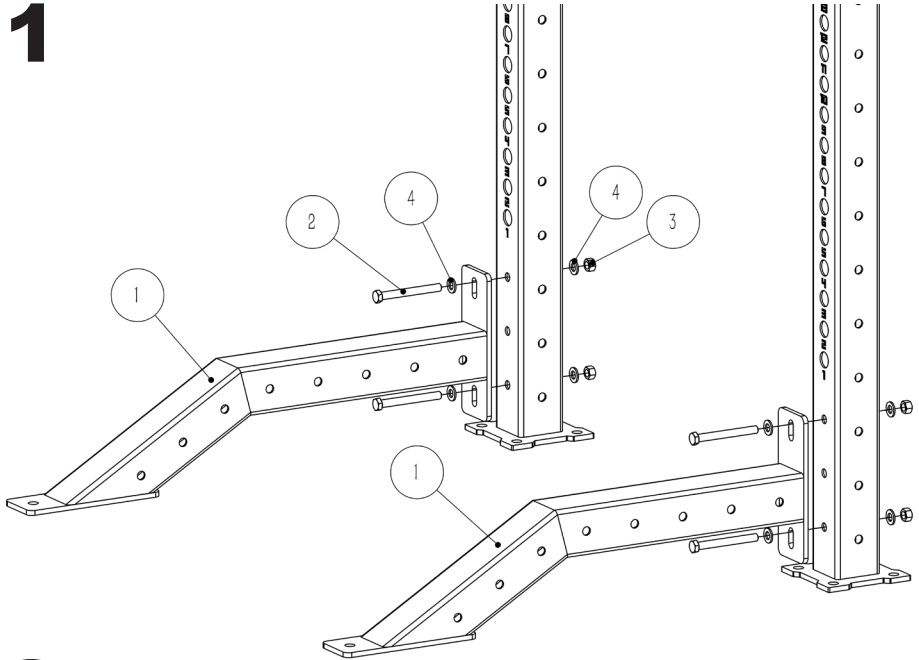

2

