

KB Cable Cross Over

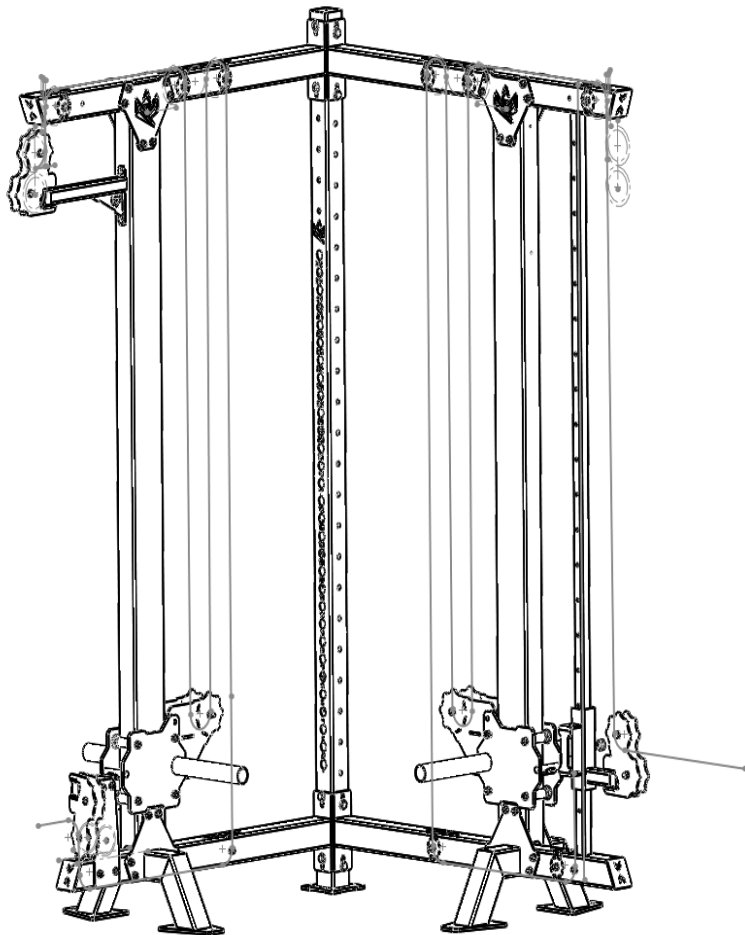

KingsBox[®]

BUILDING BETTER HUMANS

Assembly elements:

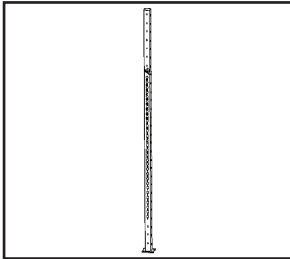

Position 1

**Upright CX Mighty
2500**

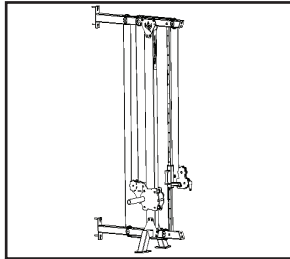

Position 2

Adj. Kit for CCO

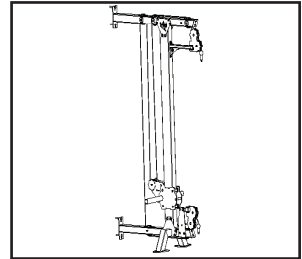

Position 3

Static Kit for CCO

Assembly instruction:

STEP: 1

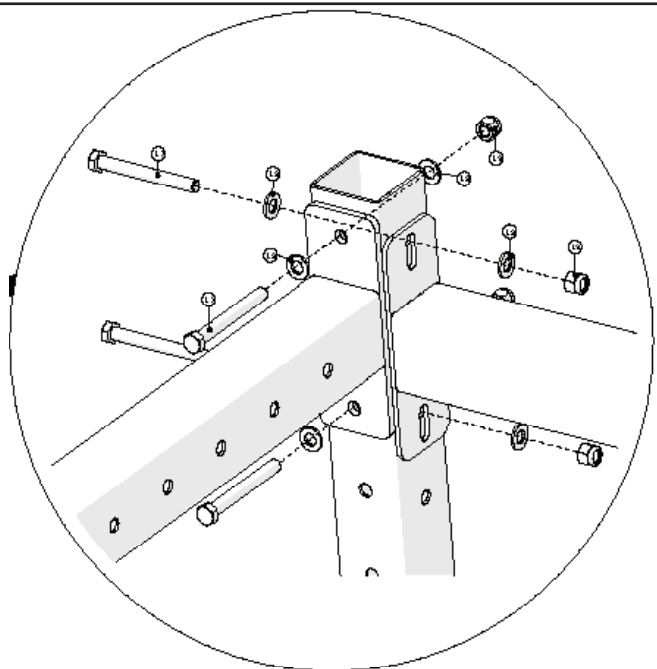

Adj. Kit for CCO

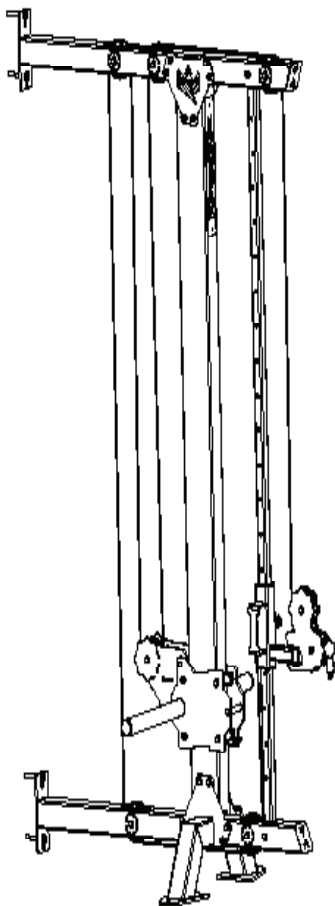

KingsBox[®]
BUILDING BETTER HUMANS

Assembly elements:

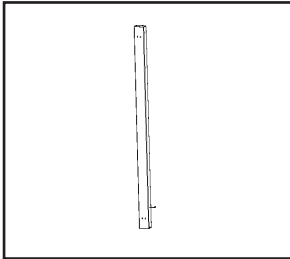

Position 1

**CCO Upright Adj.
Pulley Cart**

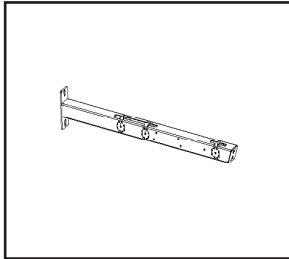

Position 2

**CCO Adj. Pulley
Profile Up**

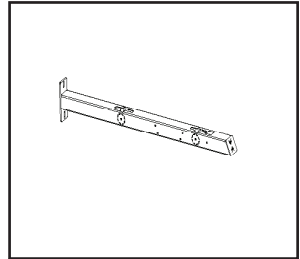

Position 3

**CCO Adj. Pulley
Profile Bottom**

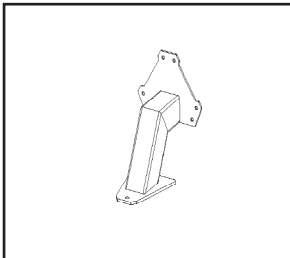

Position 4

CCO Leg

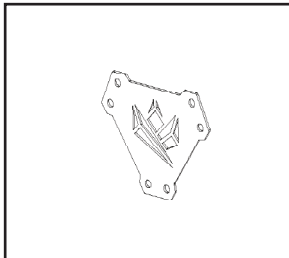

Position 5

**CCO Connecting
Plate**

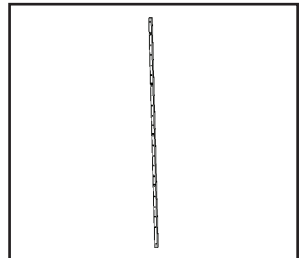

Position 6

**CCO Height Adj.
Column**

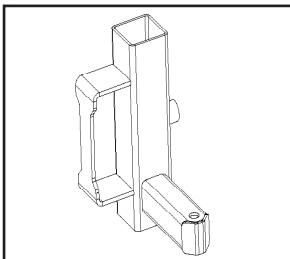

Position 7

**CCO Height Adj.
Trolley**

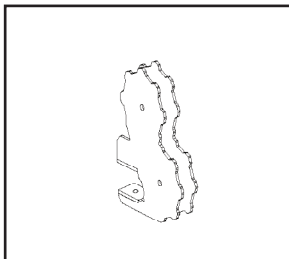

Position 8

CCO Pulley Cart

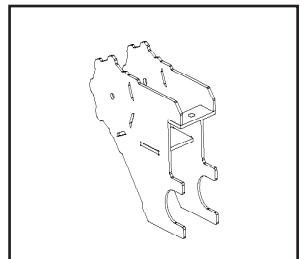

Position 9

**CCO Addon_SPS
Cart**

Assembly elements:

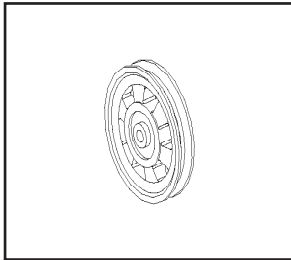

Position 10

Pulley fi114

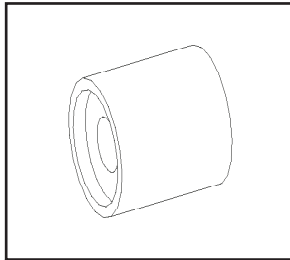

Position 11

Pulley Bush fi25

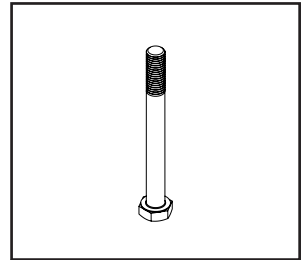

Position 12

M10x100

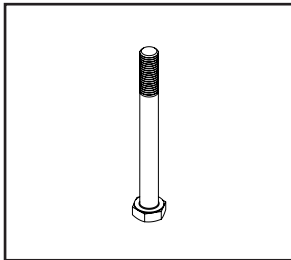

Position 13

M10x100

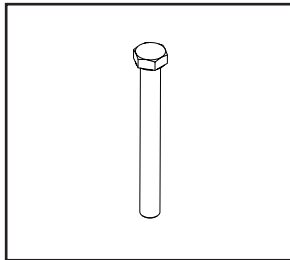

Position 14

M10x120

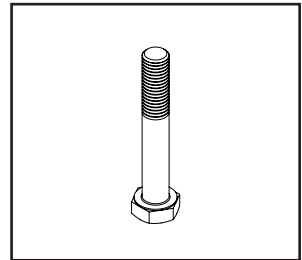

Position 15

M10x70

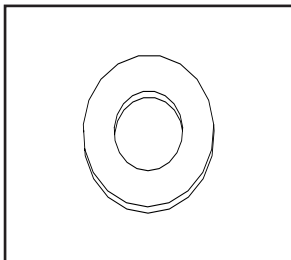

Position 16

Washer M10

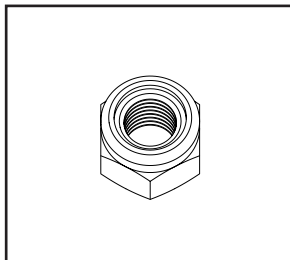

Position 17

Nut M10

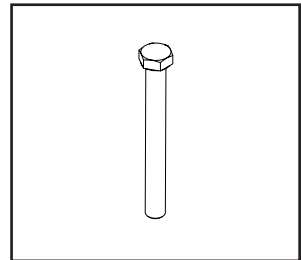

Position 18

M12x110

Assembly elements:

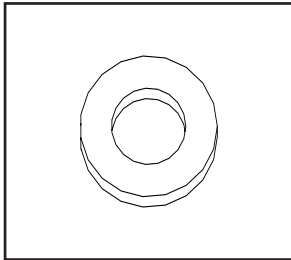

Position 19

Washer M12

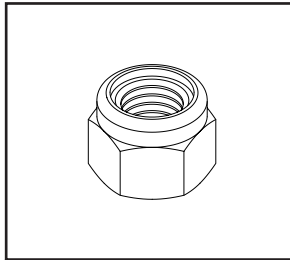

Position 20

Nut M12

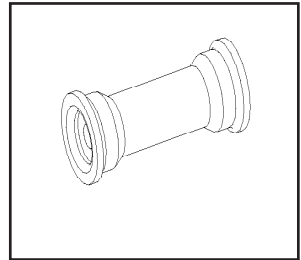

Position 21

Rower Roller

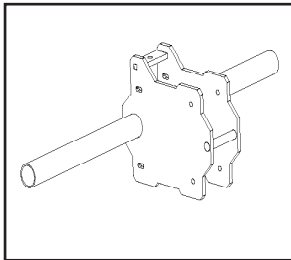

Position 22

Cart SPS

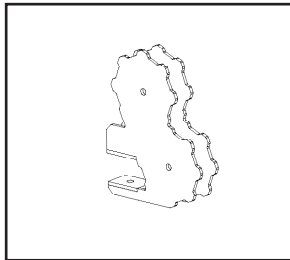

Position 23

CCO Pulley Cart

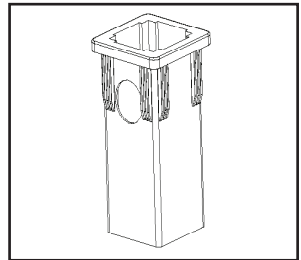

Position 24

Plastic

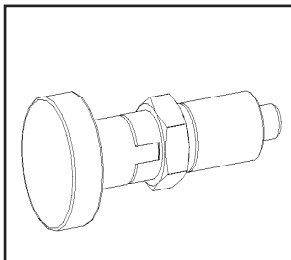

Position 25

**Index plunger
M16x1,5**

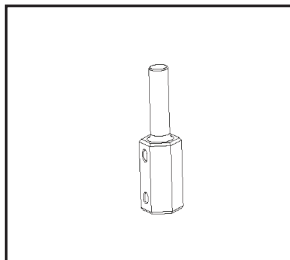

Position 26

**Cable Termination
- Thread**

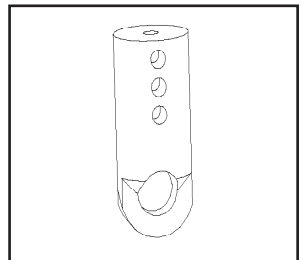

Position 27

**Cable Termination
- Ear**

Assembly elements:

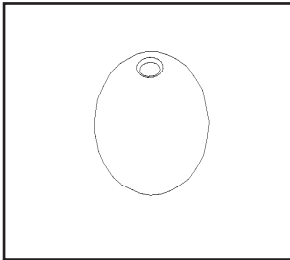

Position 28

Ball

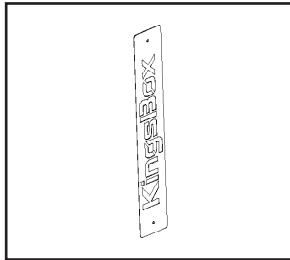

Position 29

Ped Logo F 400x60

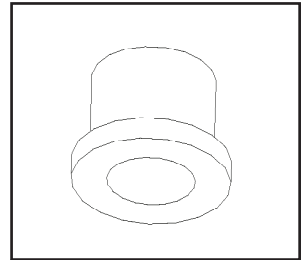

Position 31

Puša fi14-10

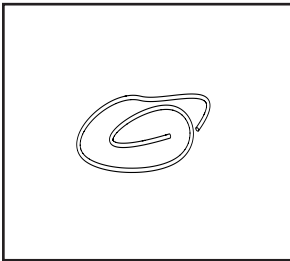

Position 32

Cable 10,5m

Assembly instruction:

STEP: 1

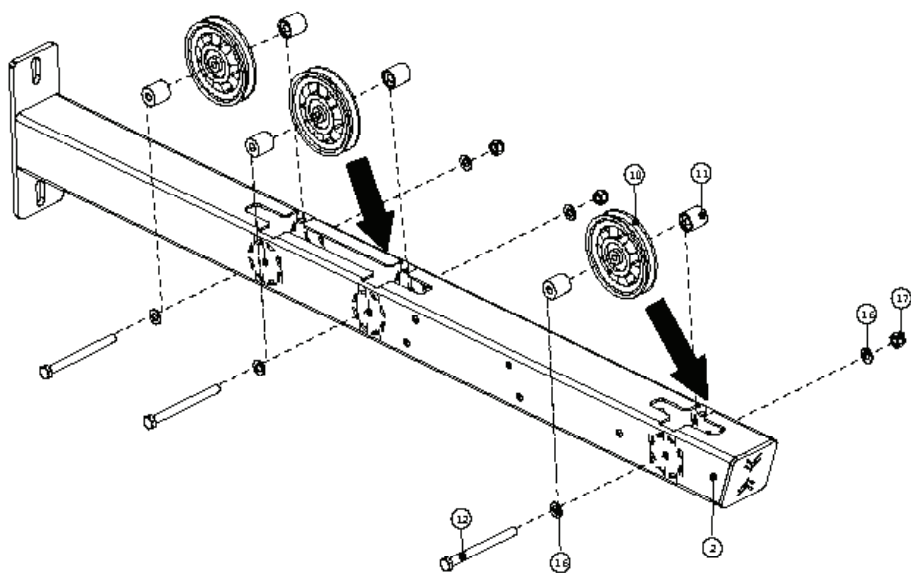

STEP: 2

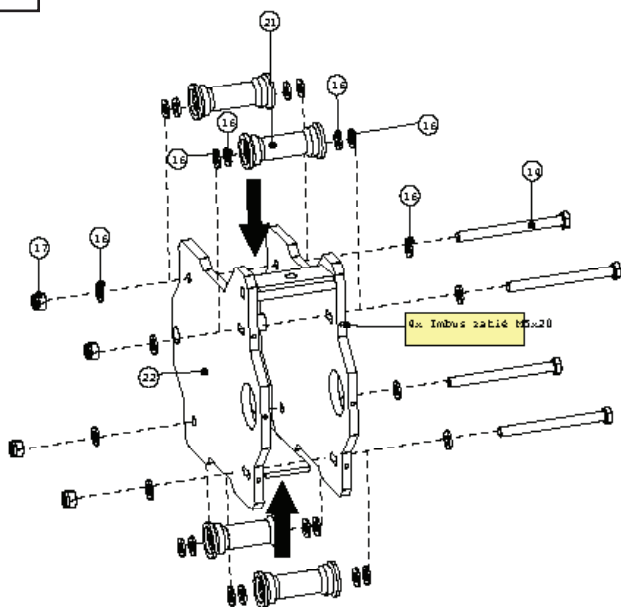

Assembly instruction:

STEP: 3

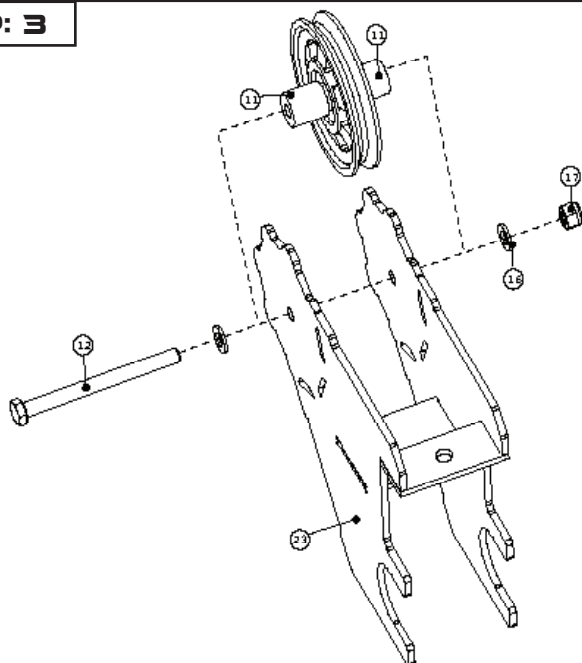

STEP: 4

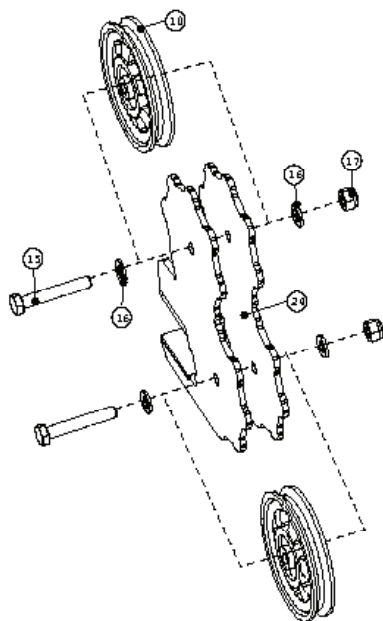

Assembly instruction:

STEP: 5

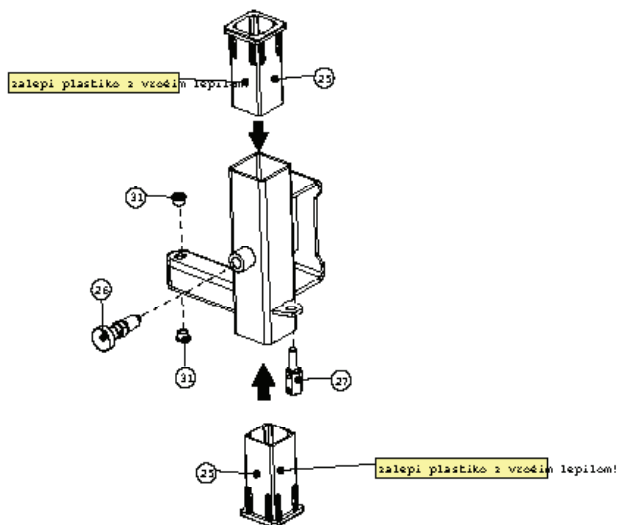

STEP: 6

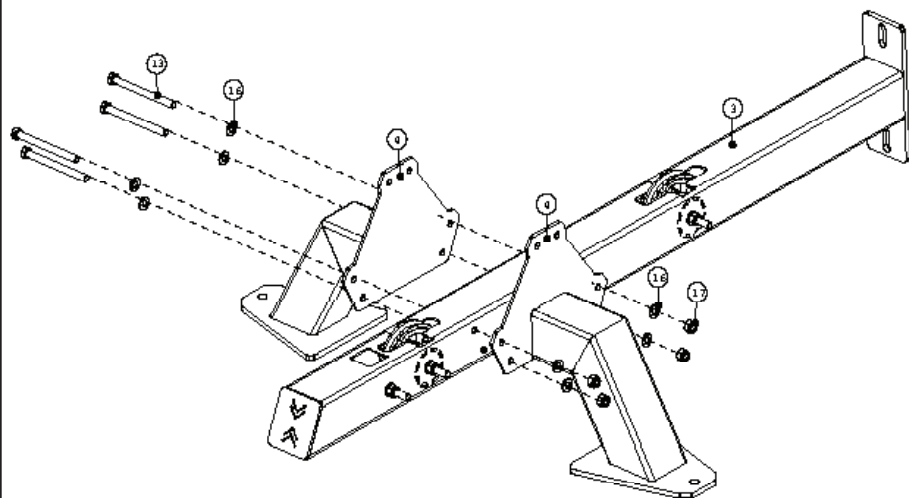

Assembly instruction:

STEP: 7

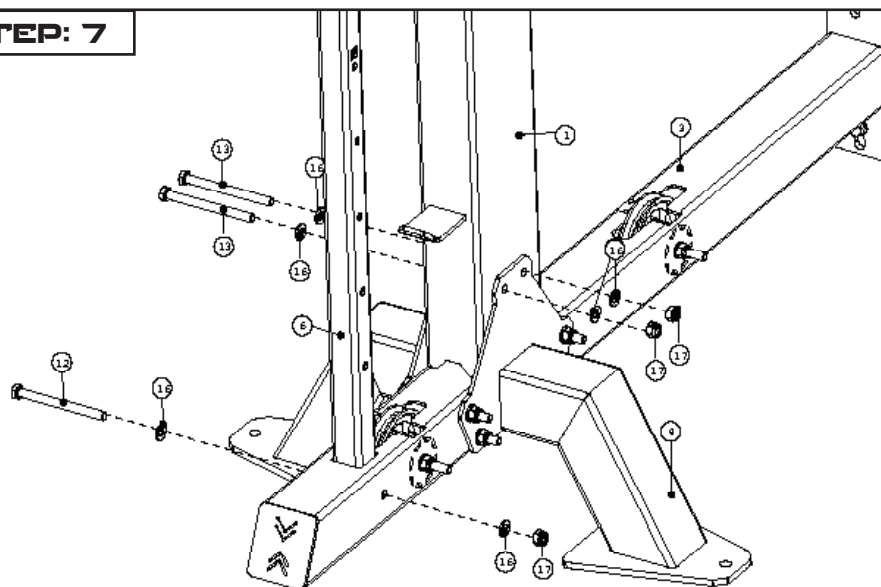

STEP: 8

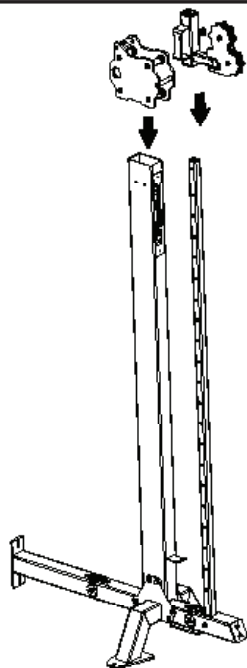

Assembly instruction:

STEP: 9

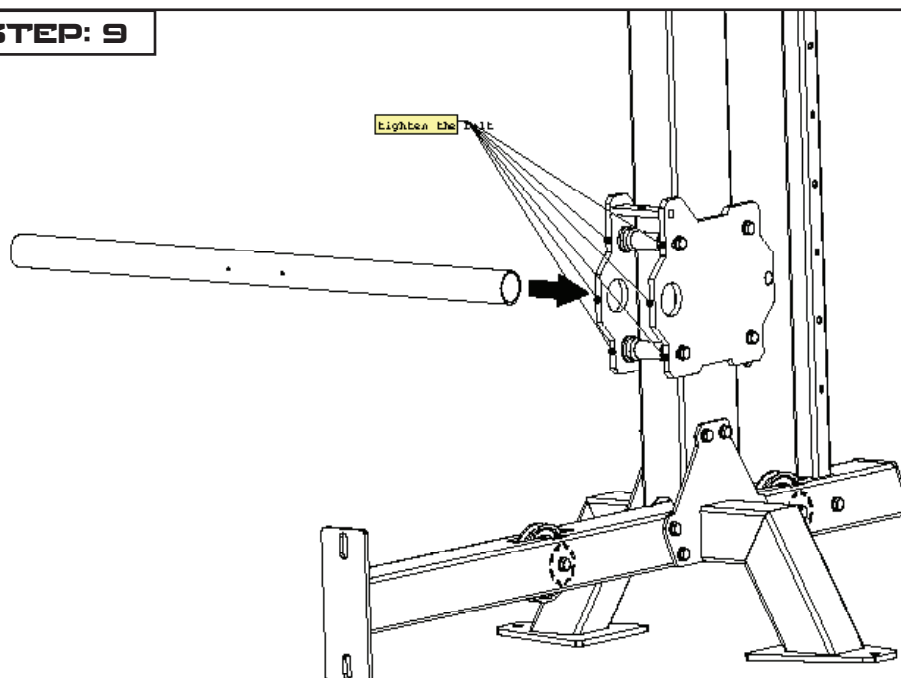

STEP: 10

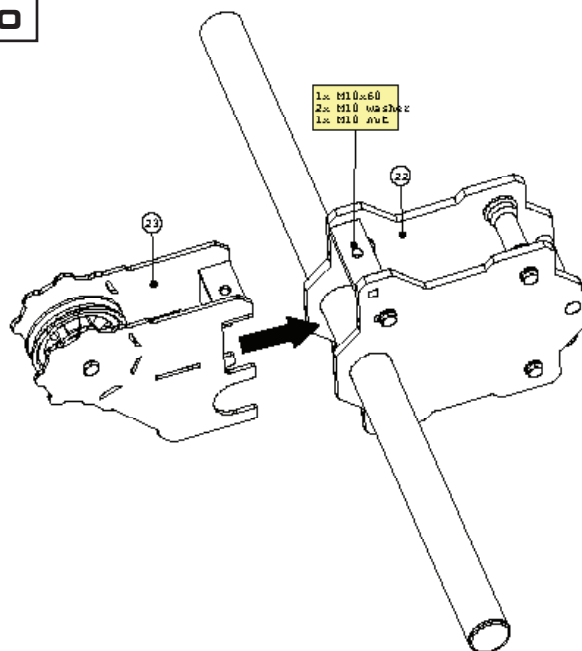

Assembly instruction:

STEP: 11

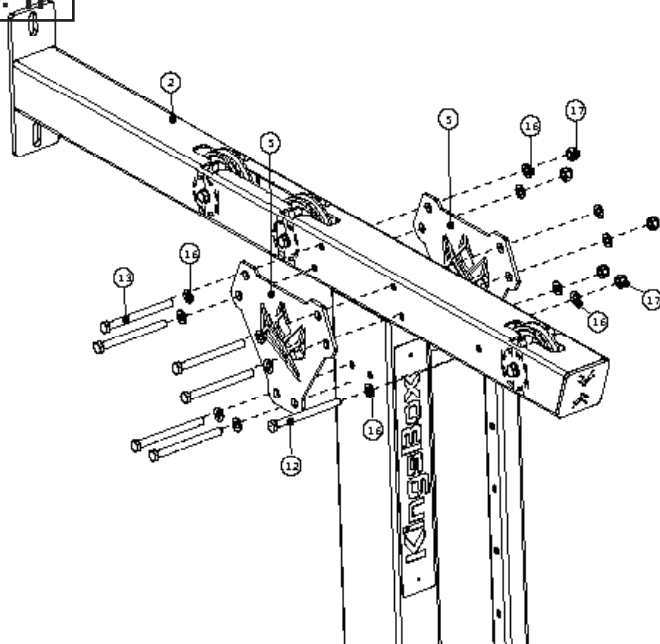

STEP: 12

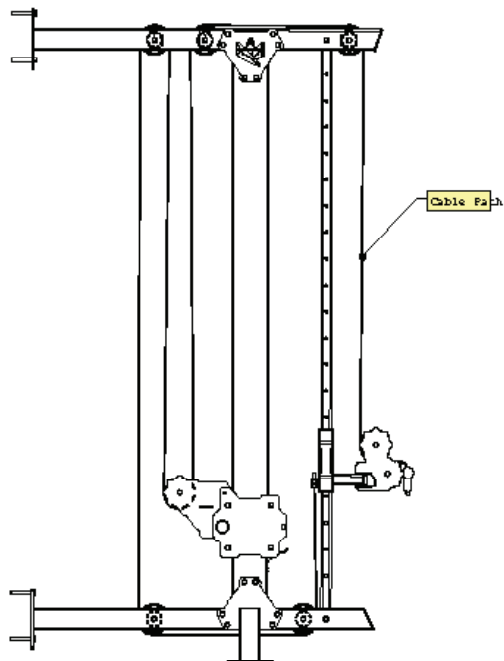

Assembly instruction:

STEP: 13

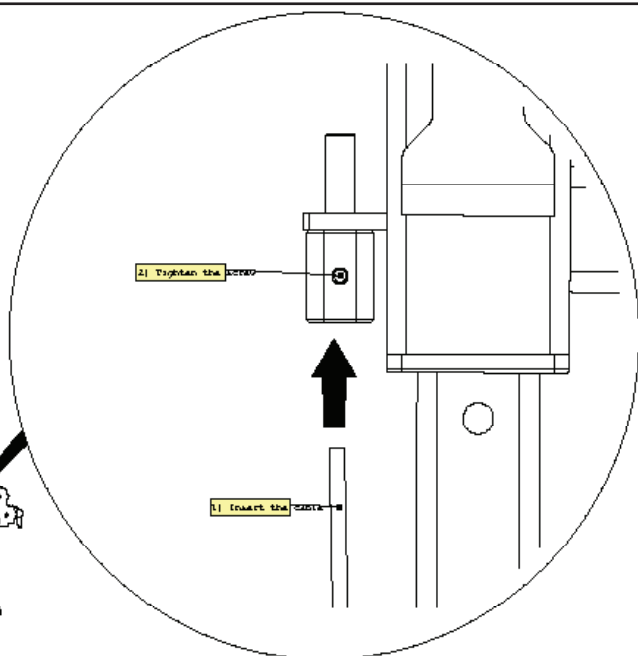
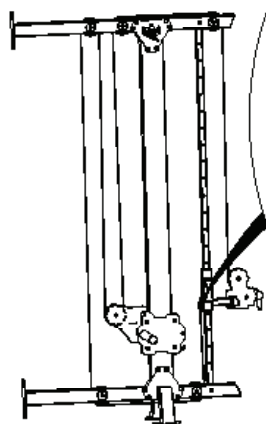

STEP: 14

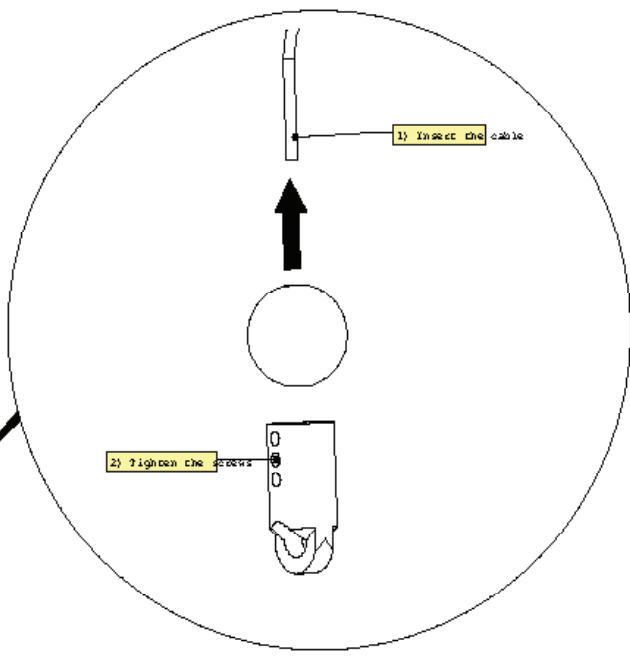
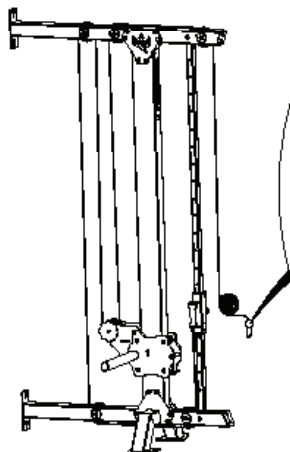

Static Kit for CCO

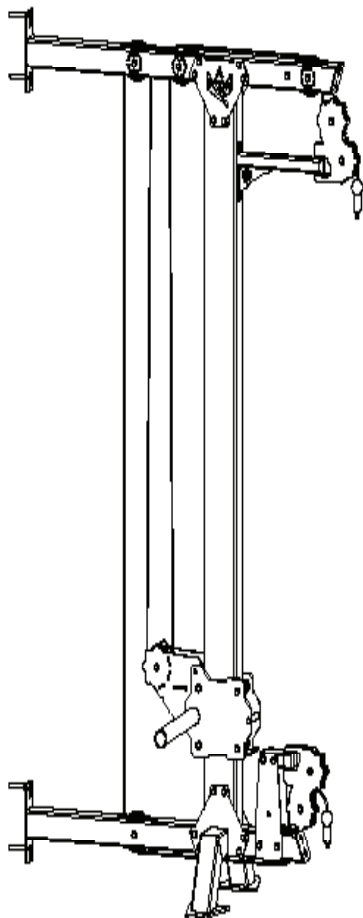

KingsBox[®]
BUILDING BETTER HUMANS

Assembly elements:

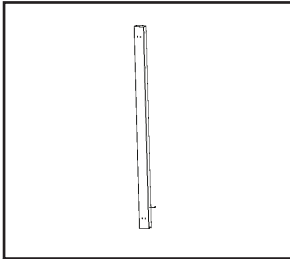

Position 1

**CCO Upright
Pulley Cart**

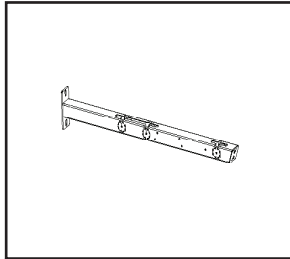

Position 2

**CCO Adj. Pulley
Profile Up**

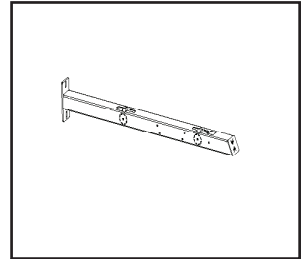

Position 3

**Pulley
Profile Down**

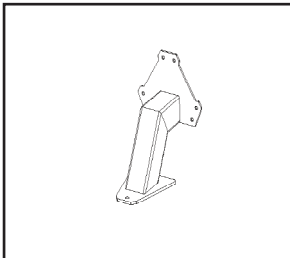

Position 4

CCO Leg

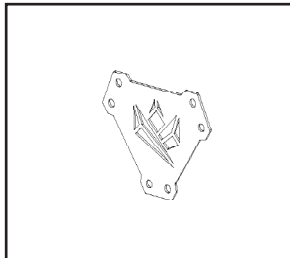

Position 5

**CCO Connecting
Plate**

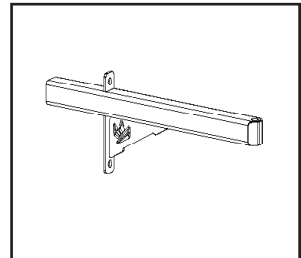

Position 6

**CCO Pulley Cart
Beam**

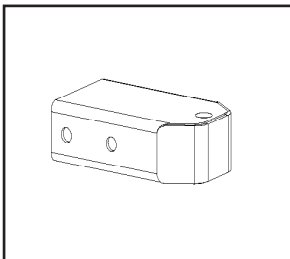

Position 7

Spacer Profile

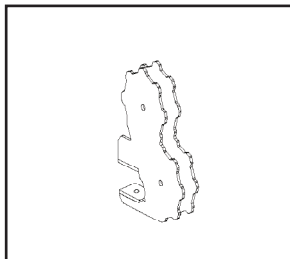

Position 8

CCO Pulley Cart

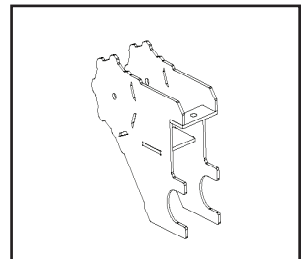

Position 9

**CCO Addon_SPS
Cart**

Assembly elements:

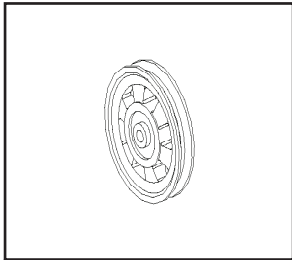

Position 10

Pulley fi114

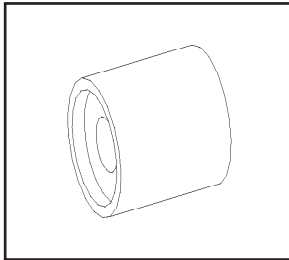

Position 11

Pulley Bush fi25

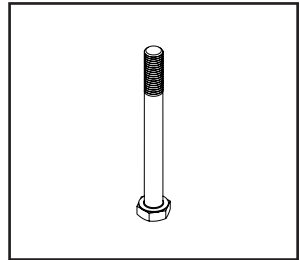

Position 12

M10x100

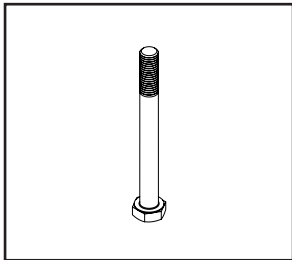

Position 13

M10x100

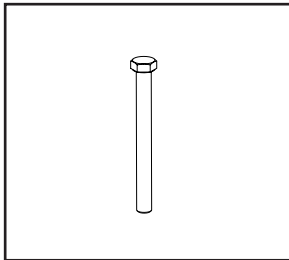

Position 14

M10x120

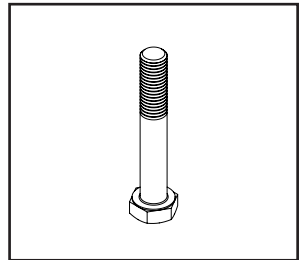

Position 15

M10x70

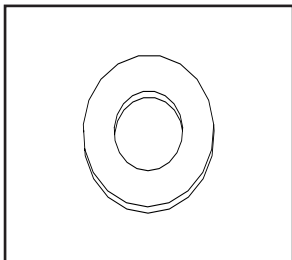

Position 16

Washer M10

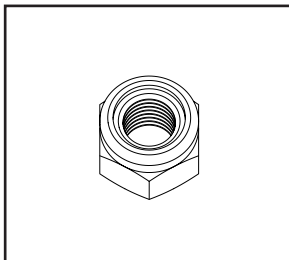

Position 17

Nut M10

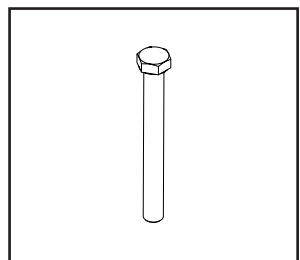

Position 18

M12x110

Assembly elements:

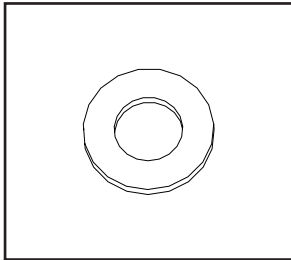

Position 19

Washer M12

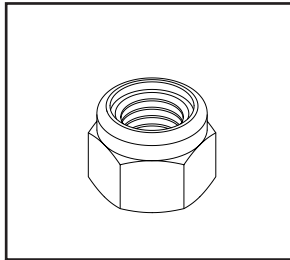

Position 20

Nut M12

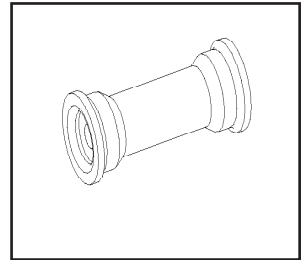

Position 21

Rower Roller

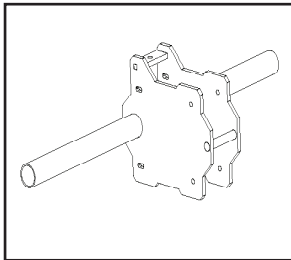

Position 22

Cart SPS

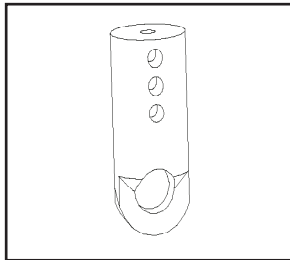

Position 23

**Cable Termination
- Ear**

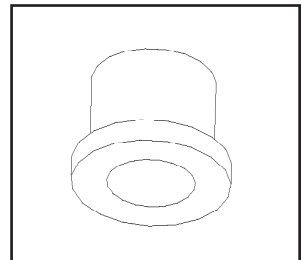

Position 24

Bush fi14-10

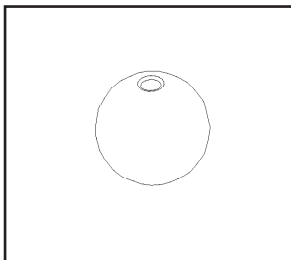

Position 25

Ball

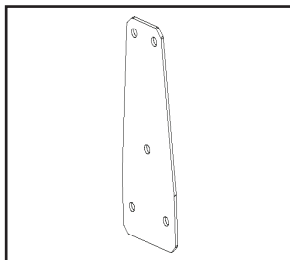

Position 26

**CCO Plate_Pulley
Cart**

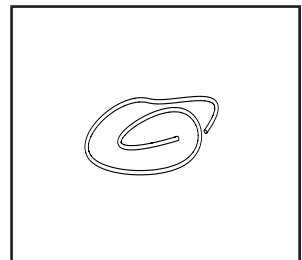

Position 27

Cable 8,5m

Assembly instruction:

STEP: 1

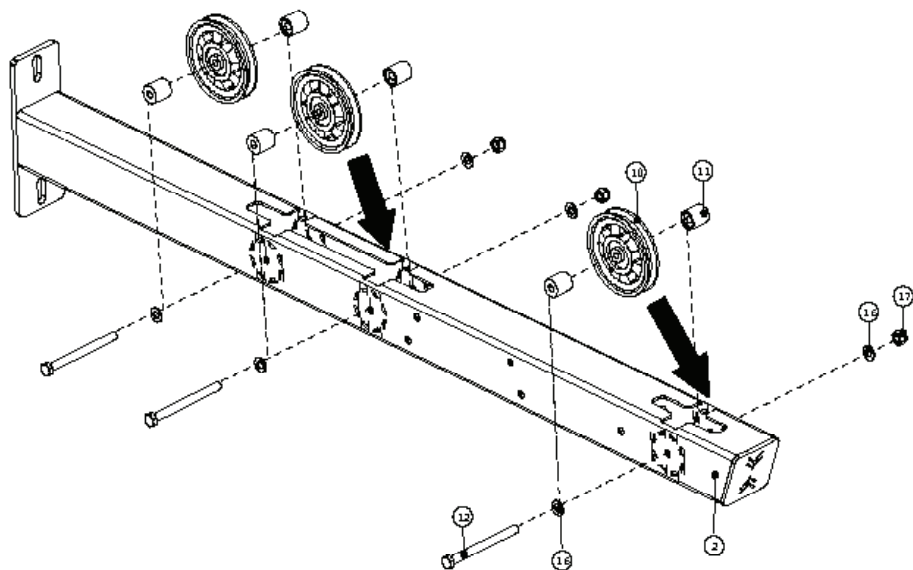

STEP: 2

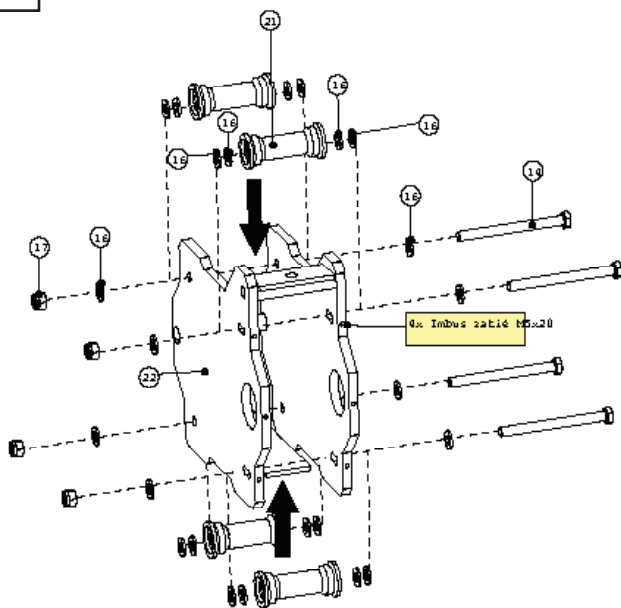

Assembly instruction:

STEP: 3

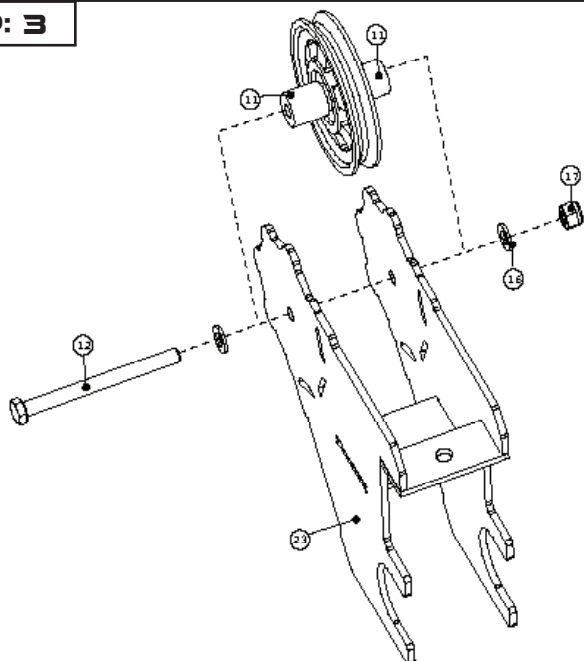

STEP: 4

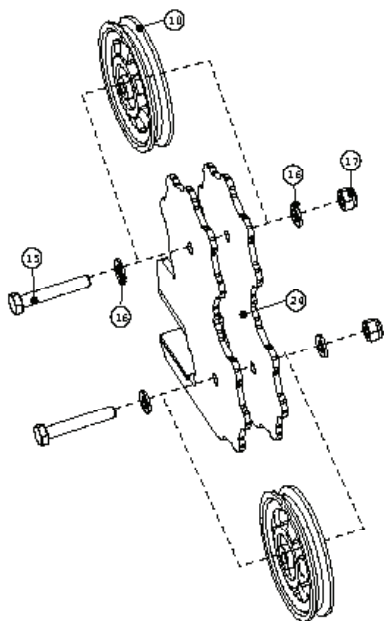

Assembly instruction:

STEP: 7

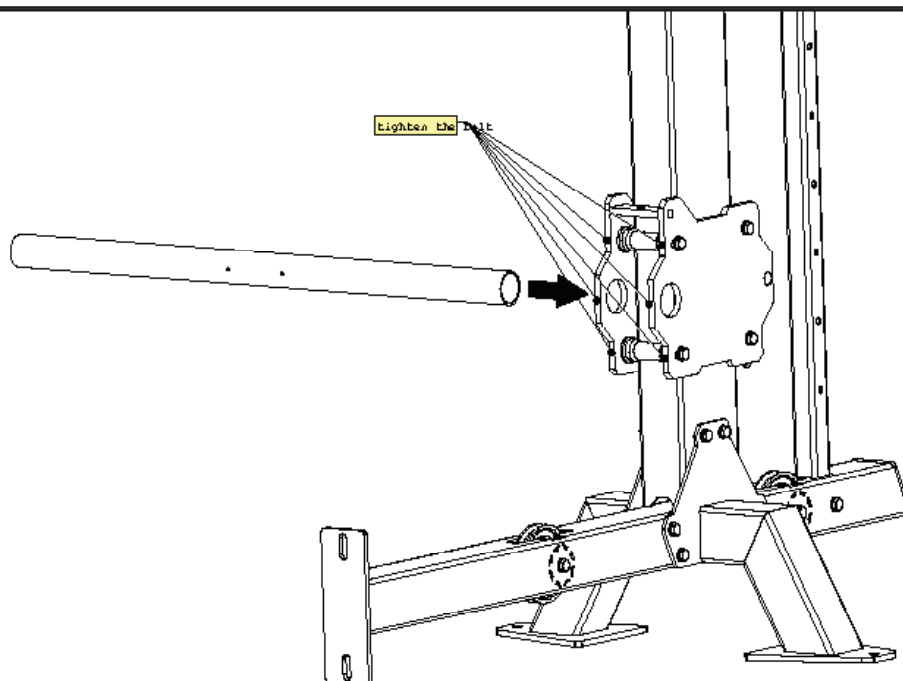
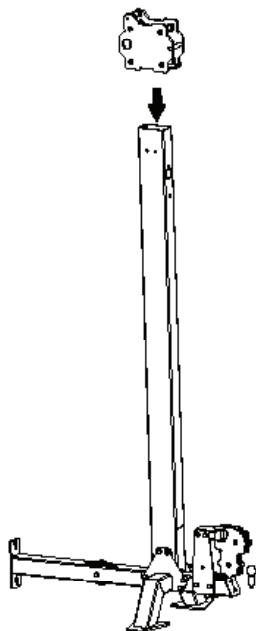

Assembly instruction:

STEP: 9

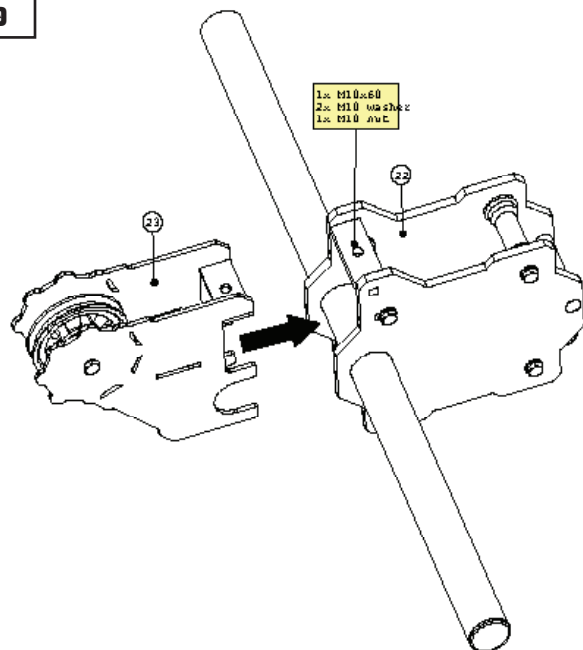

STEP: 10

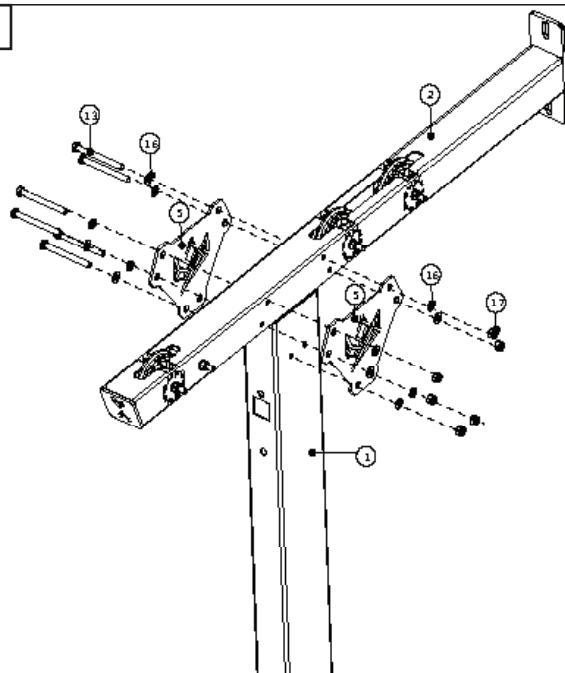

Assembly instruction:

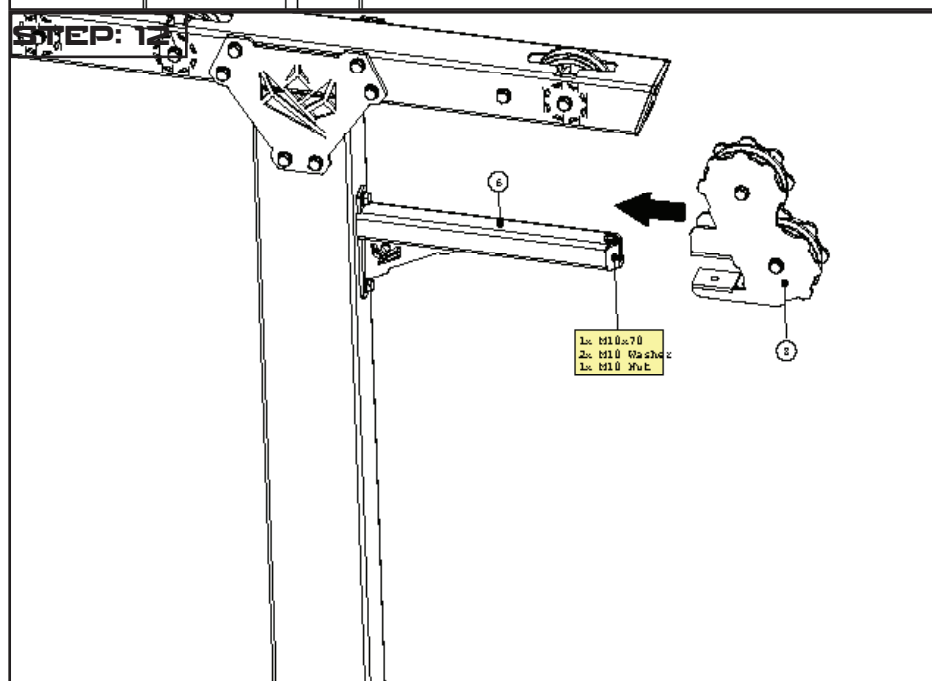
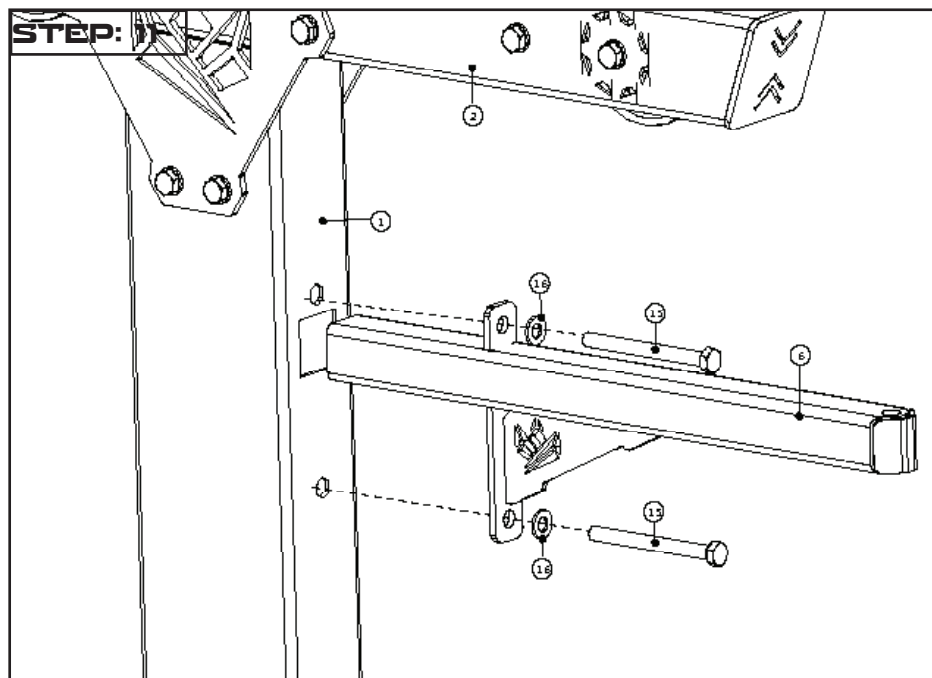

Assembly instruction:

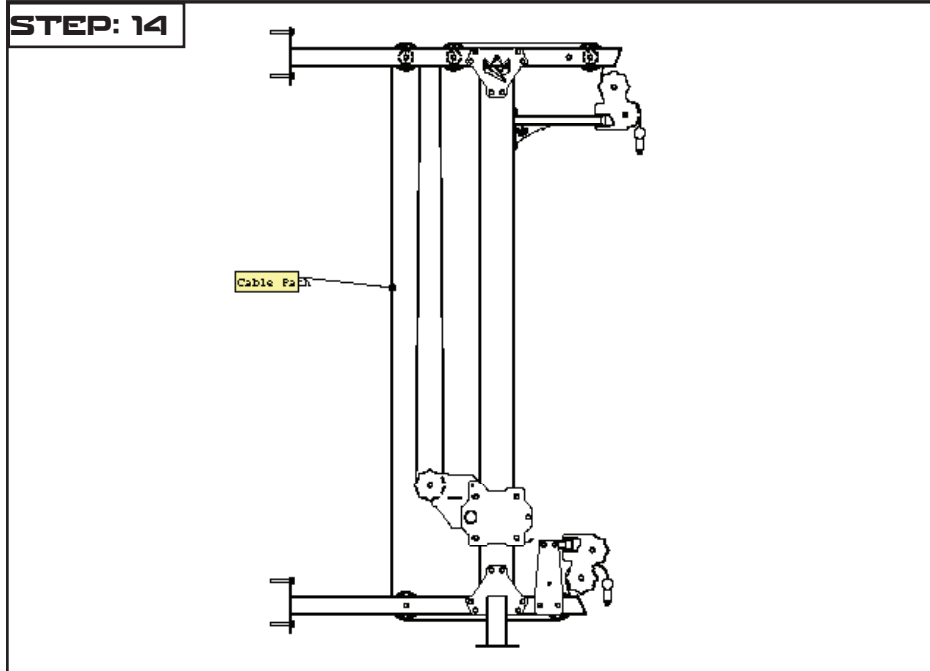
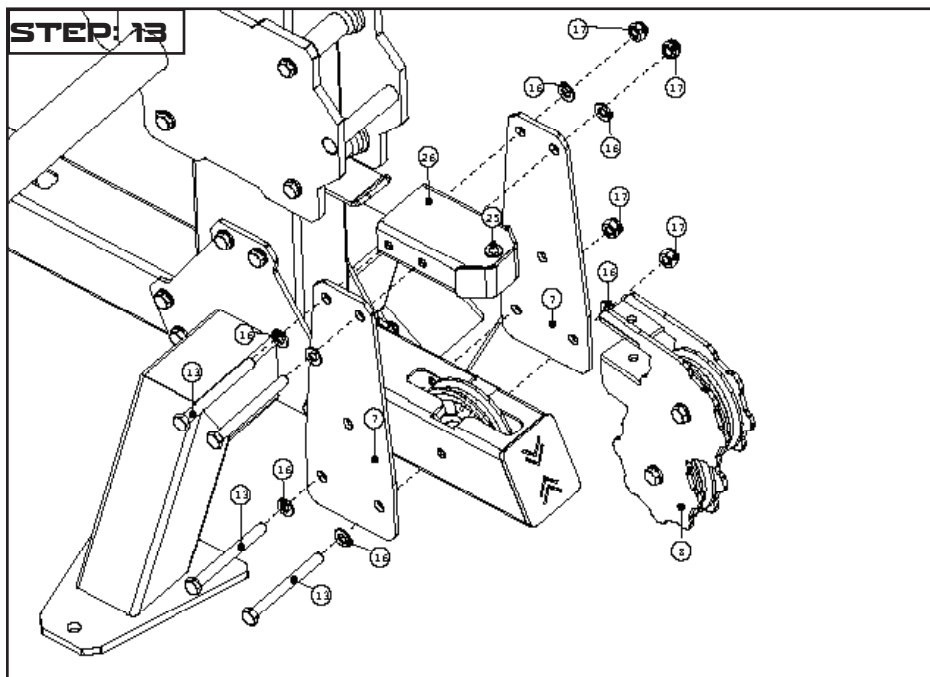

Assembly instruction:

