

Lat-Row Pulley

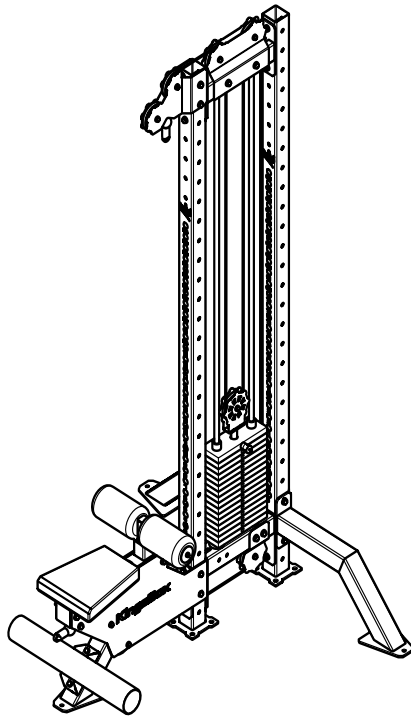

KingsBox[®]
BUILDING BETTER HUMANS

ATTENZIONE!

Se la struttura non viene fissata a terra e/o al muro, può rib-altarsi e/o provocare danni a persone o oggetti in immediata vicinanza.

I bulloni per il fissaggio del rig a muro e/o al pavimento non sono inclusi nel pacco, in quanto per diversi tipi di muro e pavimentazione bisogna utilizzare diversi tipi di bulloni d'ancoraggio.

OPOZORILO!

Če se struktura prevrne, lahko pride do resnih telesnih poškodb. Da bi preprečili nevarnost, da se ta struktura prevrne, mora biti pritrjena na steno in / ali v tla.

Vijaki za pritrjevanje strukture na steno oz. tla niso priloženi, saj različne sestave zidov oz. tal zahtevajo različne vrste pritrdilnih elementov. Uporabite take, ki ustrezajo sestavi vaše stene oz. tal.

WARNING!

If the structure is not secured to the ground and / or to the wall, it may overturn and / or cause damage to person or object in the immediate vicinity.

The fixing bolts for wall and / or floor are not included in the pack-age, since different types of anchor bolts must be used for different wall / floor types.

Assembly elements:

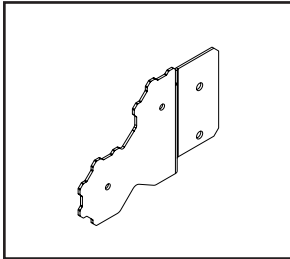

Position 1

Pulley Rig_Static
Pulley_L

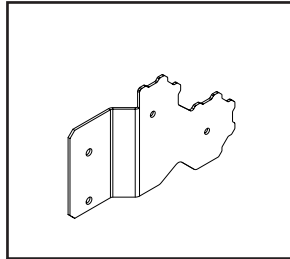

Position 2

Pulley Rig_Static
Pulley_D

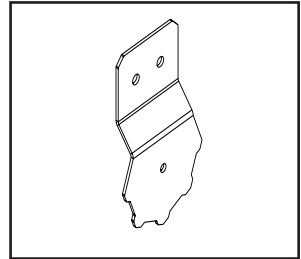

Position 3

Pulley Rig_Static
Pulley Bottom Plate

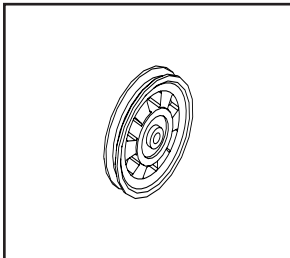

Position 4

Belt Pulley Fi 114

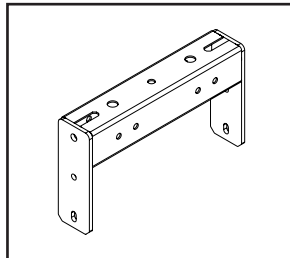

Position 5

Pulley Rig_Connecting
Bottom 400

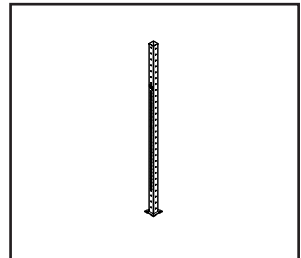

Position 6

Upright CX Mighty
2500 v

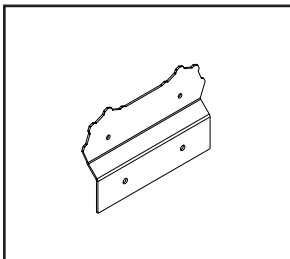

Position 7

Pulley Rig_Static Pulley
Plate_D

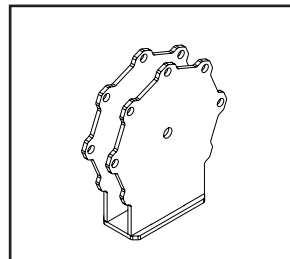

Position 8

PT_Stack Pulley
Holder

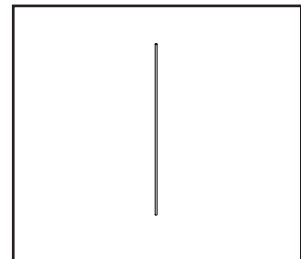

Position 9

WS_Guide Rod

Assembly elements:

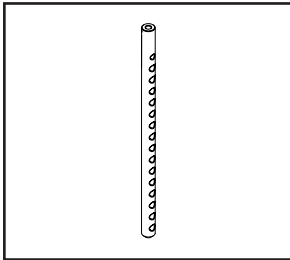

Position 10

**WS_Selector
Bar_50KG**

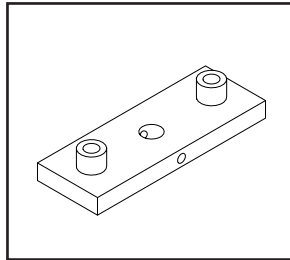

Position 11

WS-50_Top Plate

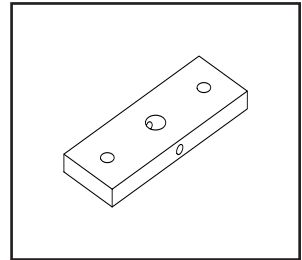

Position 12

WS-50 Weight Stack

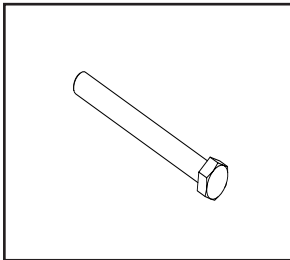

Position 13

M12x110

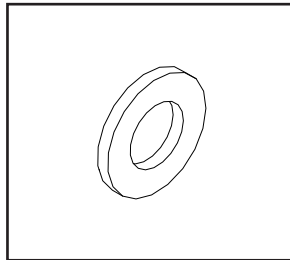

Position 14

M12 Washer

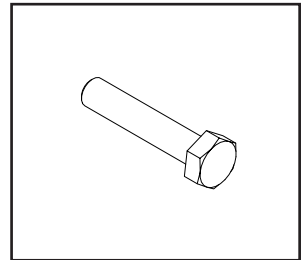

Position 15

M10x50

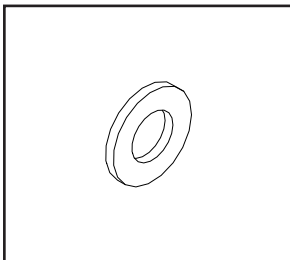

Position 16

M10 Washer

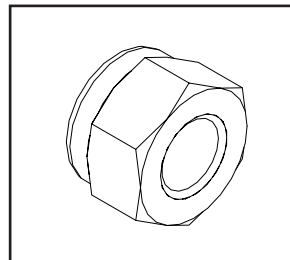

Position 17

M10 Nut

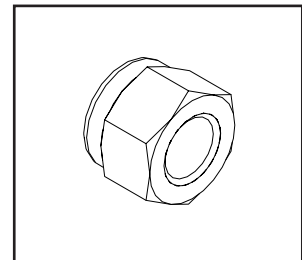

Position 18

M12 Nut

Assembly elements:

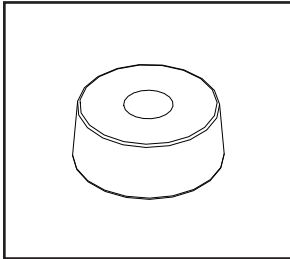

Position 19

WS_Rubber Cushion

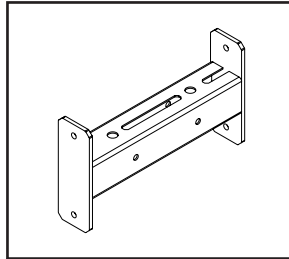

Position 20

Pulley Rig_Connecting Profile 400

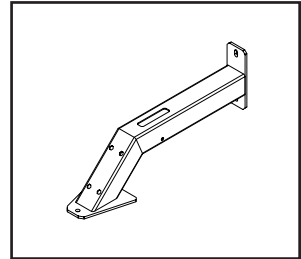

Position 21

Pulley Rig_Connecting Profile 400

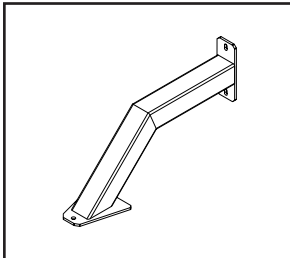

Position 22

WS_Rubber Cushion

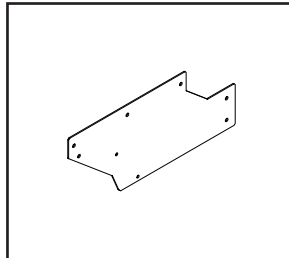

Position 23

Pulley Rig_Connecting Profile 400

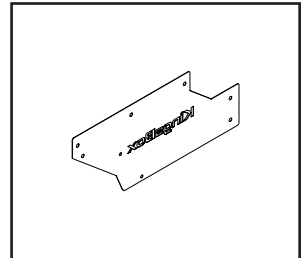

Position 24

Pulley Rig_Connecting Profile 400

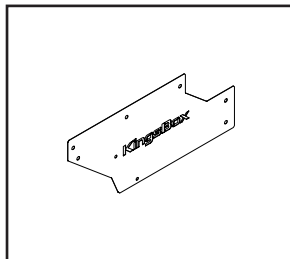

Position 25

WS_Rubber Cushion

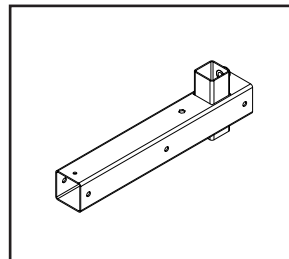

Position 26

Pulley Rig_Connecting Profile 400

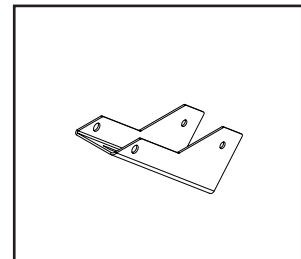

Position 27

Pulley Rig_Connecting Profile 400

Assembly elements:

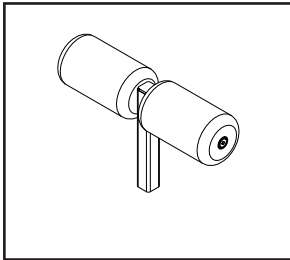

Position 28

**WS_Selector
Bar_50KG**

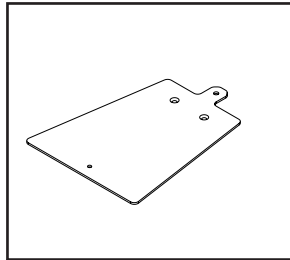

Position 29

WS-50_Top Plate

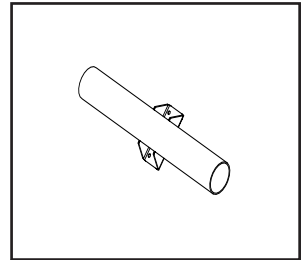

Position 30

WS-50 Weight Stack

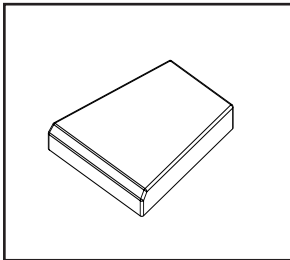

Position 31

M12x110

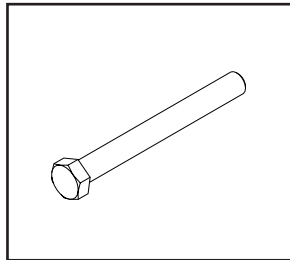

Position 32

M12x120

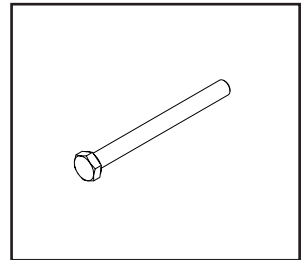

Position 33

M10x10

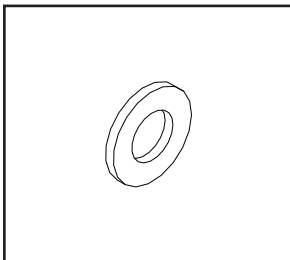

Position 34

M10 Washer

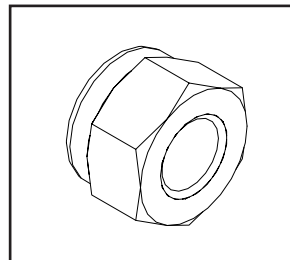

Position 35

M10 Nut

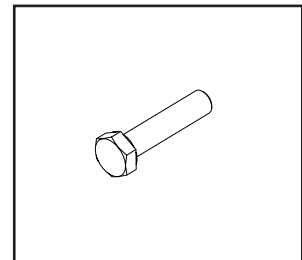

Position 36

M10x30

Assembly elements:

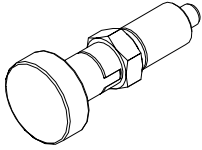

Position 37

Index Plunger

Assembly instruction:

STEP: 1

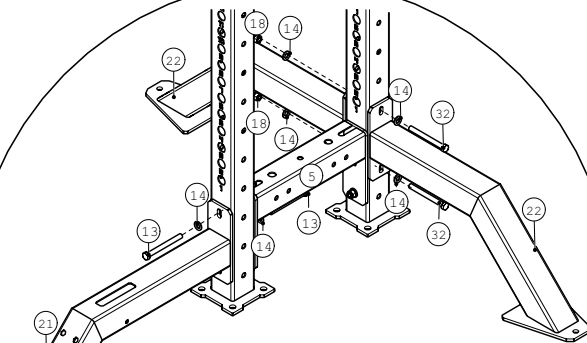
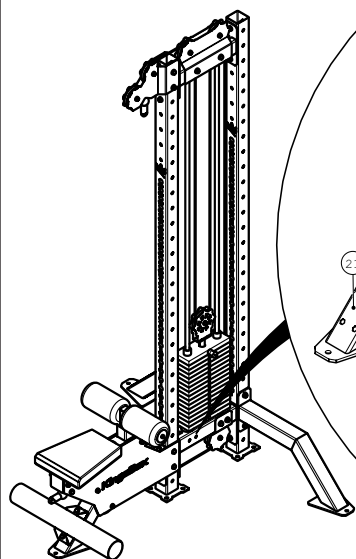

STEP

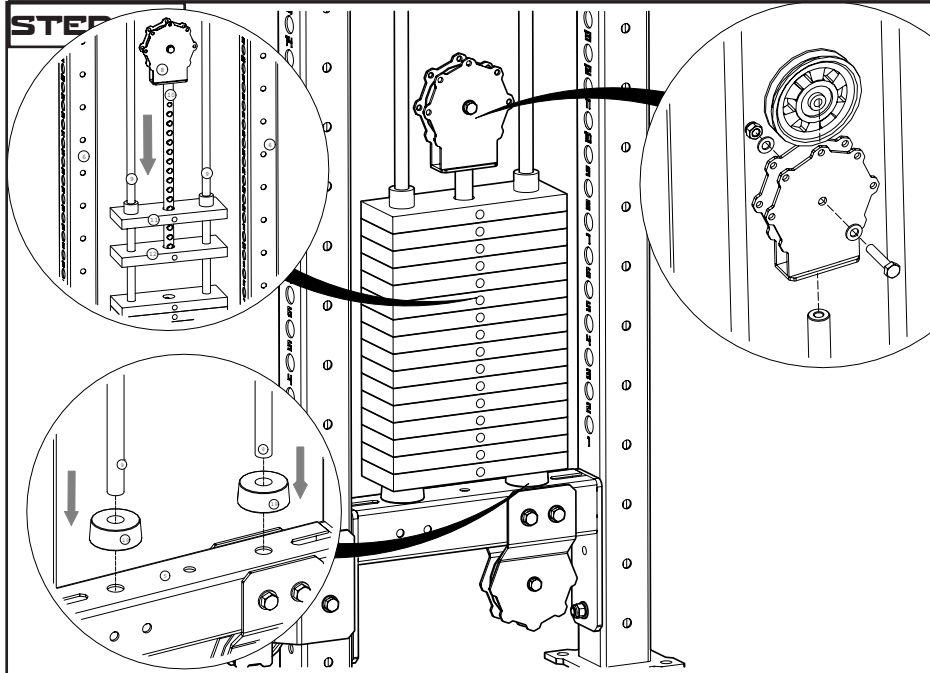

Assembly instruction:

STEP: 5

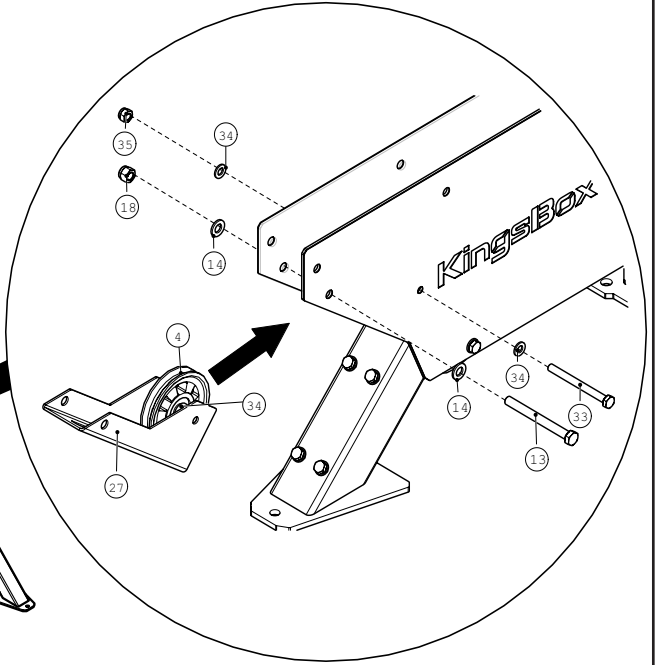
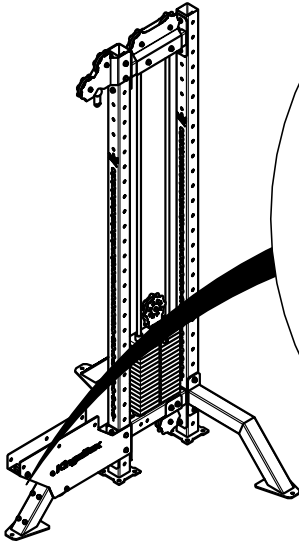

STEP: 6

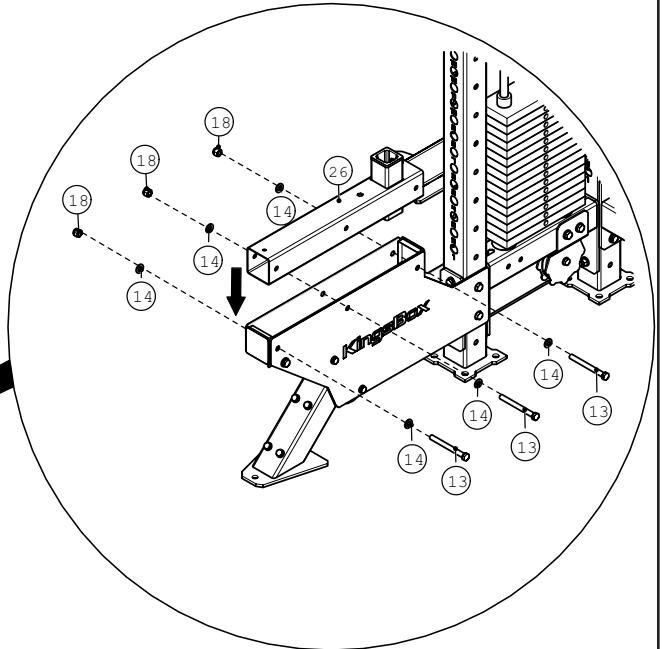
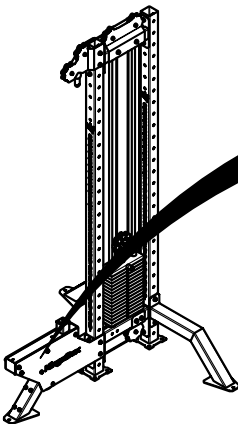

Assembly instruction:

STEP: 7

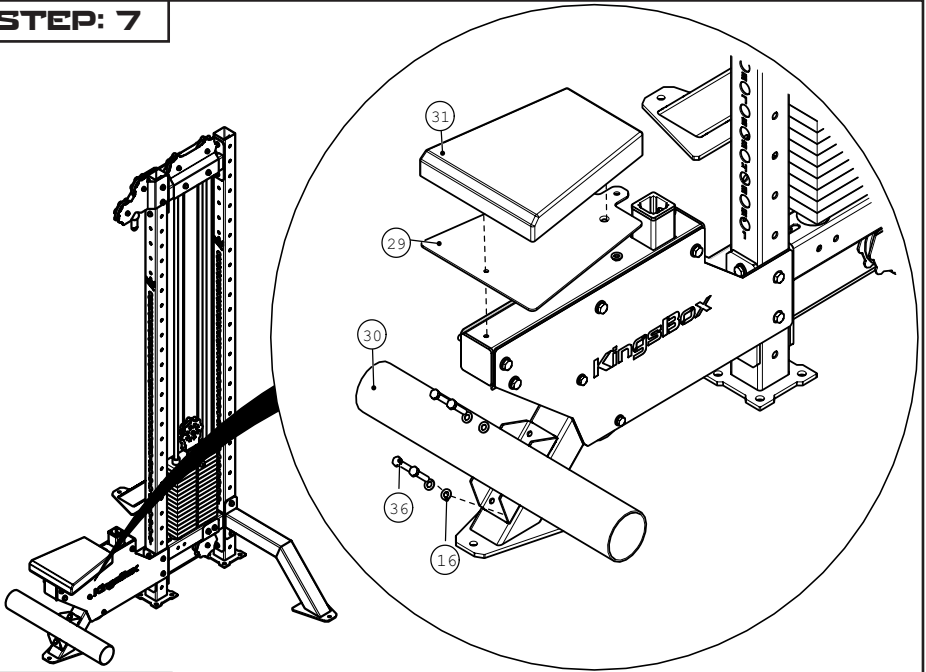

STEP: 8

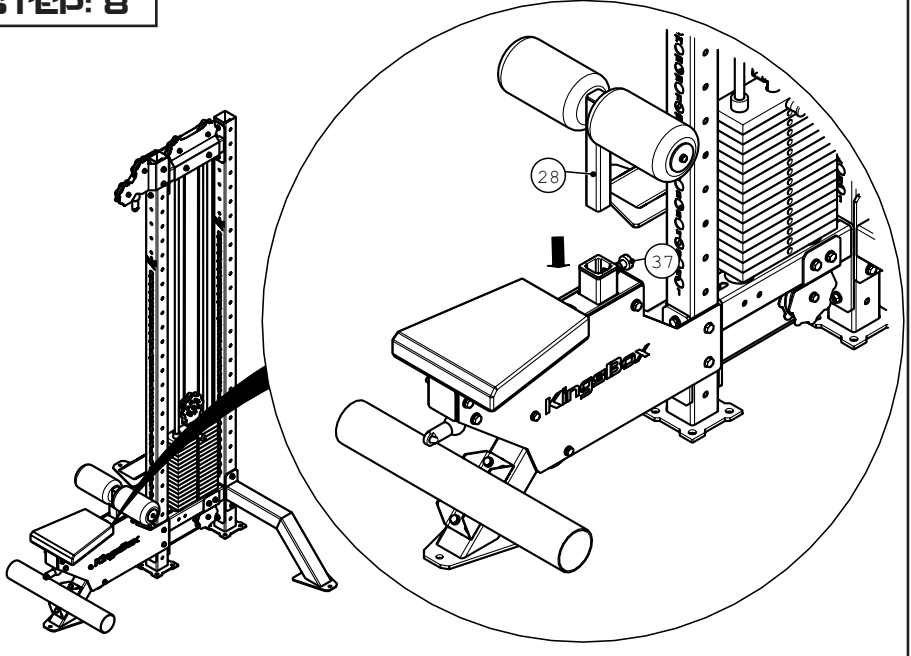

Assembly instruction:

STEP: 9

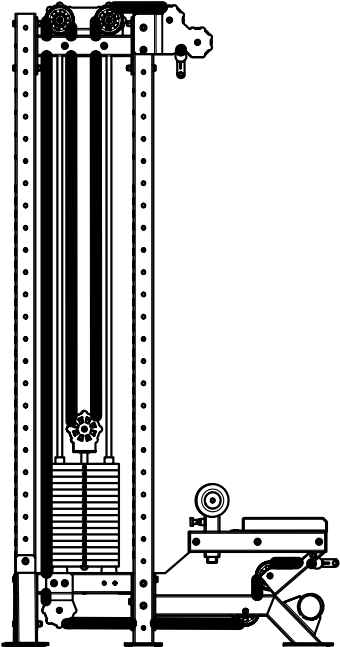

STEP: 10

