

Ultimate Adjustable Bench

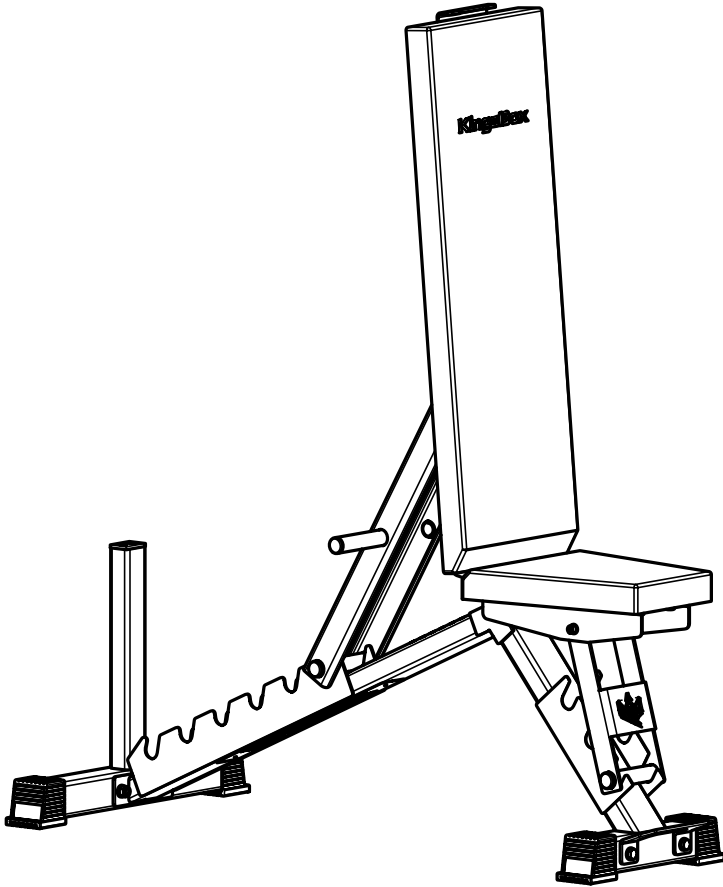

KingsBox[®]
BUILDING BETTER HUMANS

ATTENZIONE!

Se la struttura non viene fissata a terra e/o al muro, può rib-altarsi e/o provocare danni a persone o oggetti in immediata vicinanza.

I bulloni per il fissaggio del rig a muro e/o al pavimento non sono inclusi nel pacco, in quanto per diversi tipi di muro e pavimentazione bisogna utilizzare diversi tipi di bulloni d'ancoraggio.

OPOZORILO!

Če se struktura prevrne, lahko pride do resnih telesnih poškodb. Da bi preprečili nevarnost, da se ta struktura prevrne, mora biti pritrjena na steno in / ali v tla.

Vijaki za pritrjevanje strukture na steno oz. tla niso priloženi, saj različne sestave zidov oz. tal zahtevajo različne vrste pritrdilnih elementov. Uporabite take, ki ustrezajo sestavi vaše stene oz. tal.

WARNING!

If the structure is not secured to the ground and / or to the wall, it may overturn and / or cause damage to person or object in the immediate vicinity.

The fixing bolts for wall and / or floor are not included in the pack-age, since different types of anchor bolts must be used for different wall / floor types.

Assembly elements:

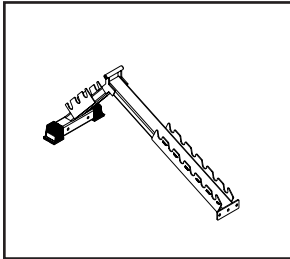

Position 1

**Adj. Bench II. Frame
Welded**

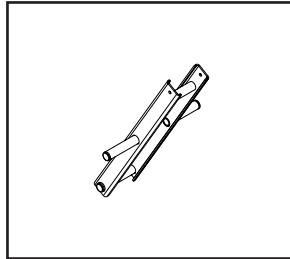

Position 2

Adj. Back Link II.

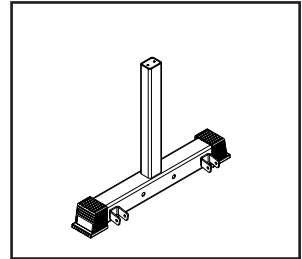

Position 3

Adj. Bench Leg II.

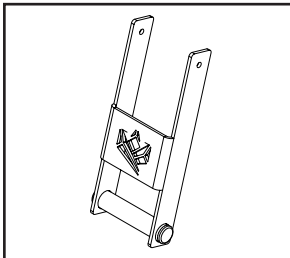

Position 4

**Adjustable Front
Link II.**

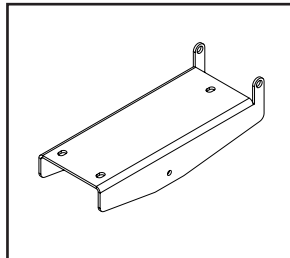

Position 5

Front Pillow Frame II.

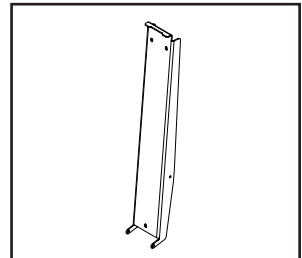

Position 6

Back Pillow Frame II.

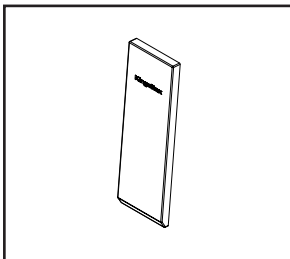

Position 7

**Adjustable Front
Pillow II.**

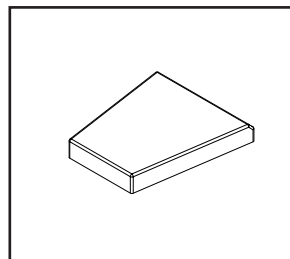

Position 8

**Adjustable Back Pil-
low II.**



Assembly elements:



Position 10

M8 Nuts

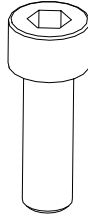

Position 11

M8x25

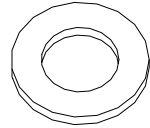

Position 12

M8 Washer

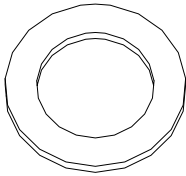

Position 13

M12 Cooper Washer



Position 14

M10x80

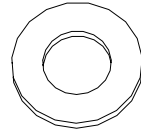

Position 15

M10 Washer



Position 16

M10 Nuts

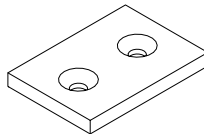

Position 17

J Cup S Plastic II



Position 18

M6x50

Assembly elements:

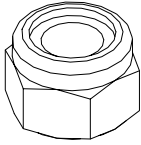

Position 19

M6 Nuts

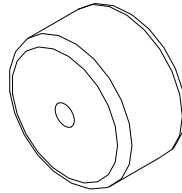

Position 20

Wheel 50 BV

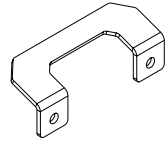

Position 21

Bench Handle

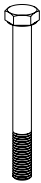

Position 22

M10x80

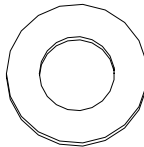

Position 23

M6 Washer

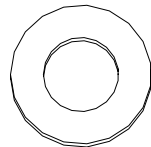

Position 24

M5 Flat Head

Assembly instruction:

STEP: 1

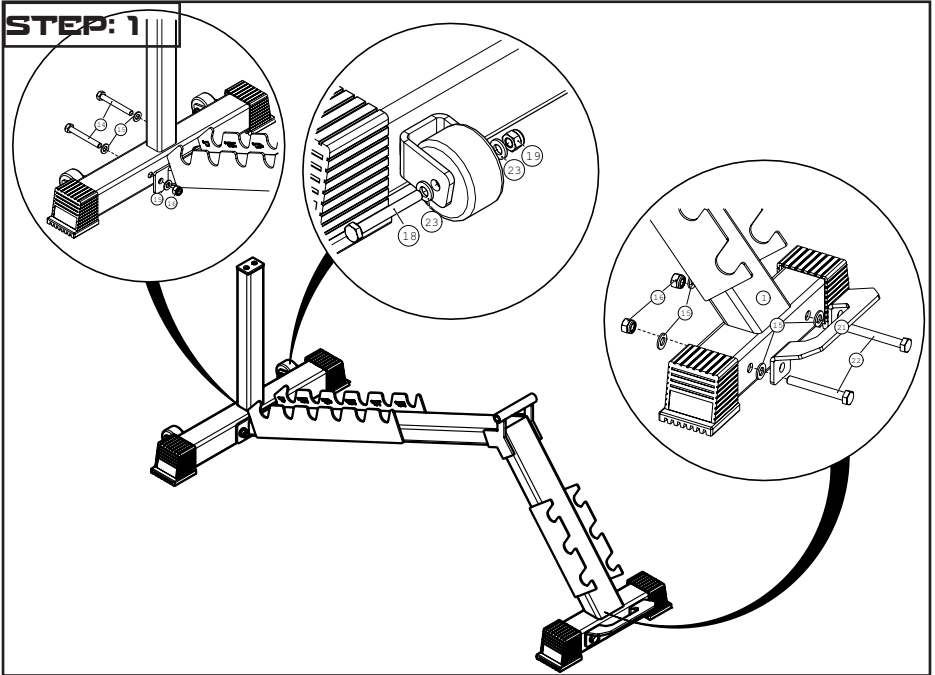

STEP: 2

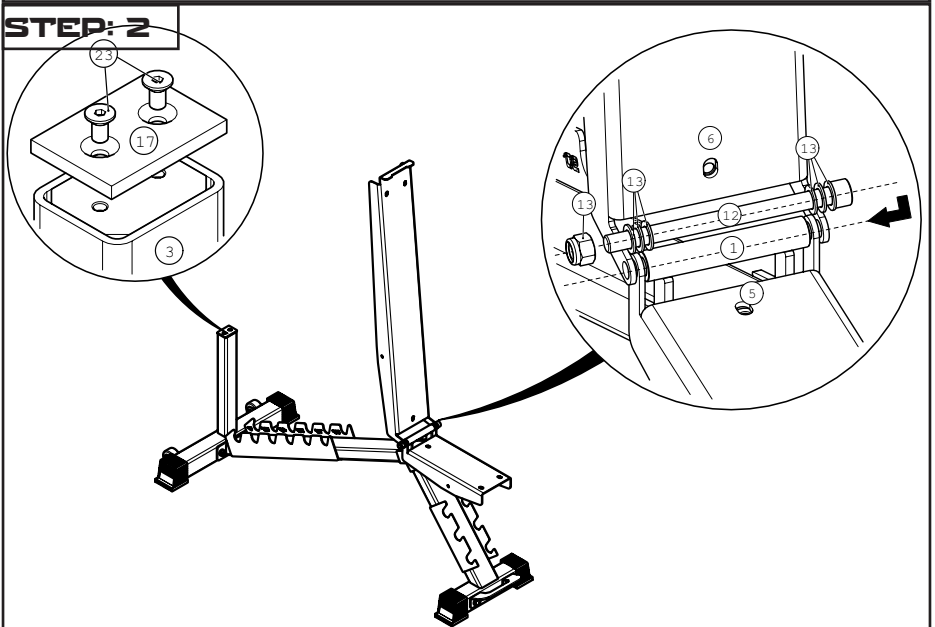

Assembly instruction:

STEP: 3

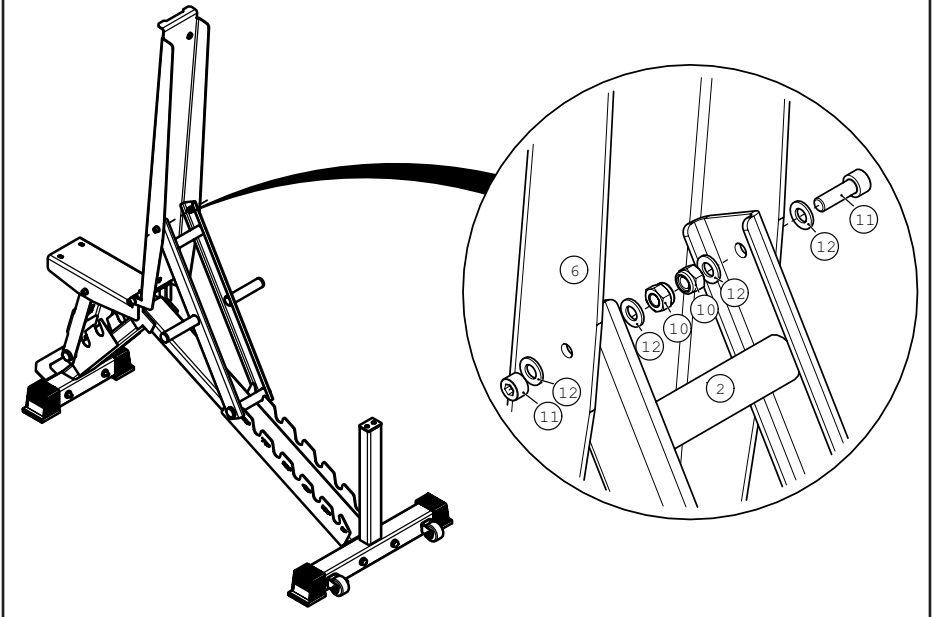

STEP: 4

