

KB Bumper Cart 2.0

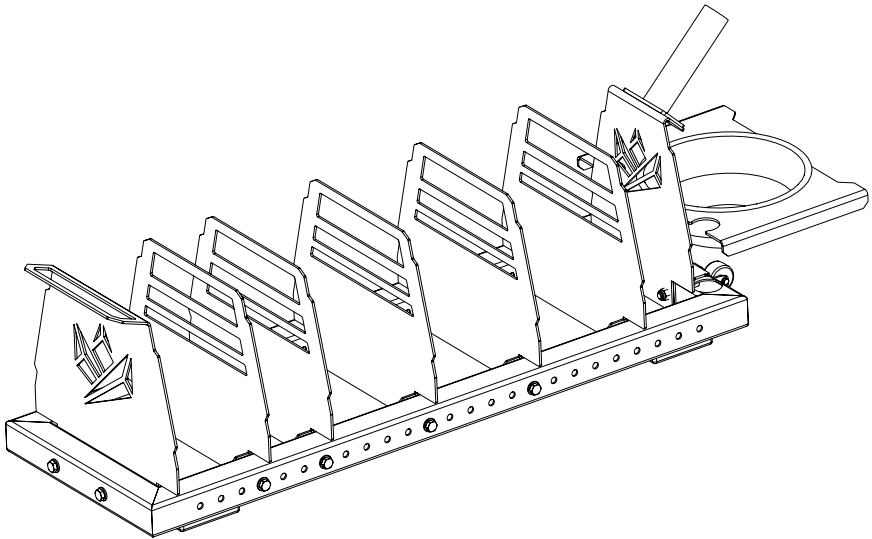

KingsBox[®]
BUILDING BETTER HUMANS

Assembly elements:

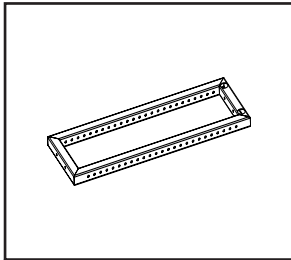

Position 1

**Bumper Cart 2.0_
Frame**

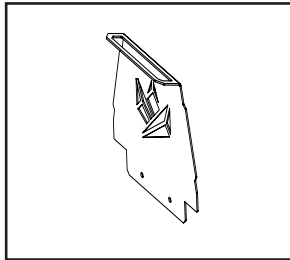

Position 2

**Bumper Cart_Handle
Plate**

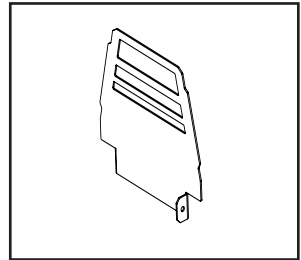

Position 3

**Bumper Cart_
Separation Plate**

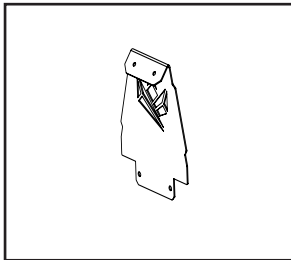

Position 4

**Bumper Cart_
Storage Plate**

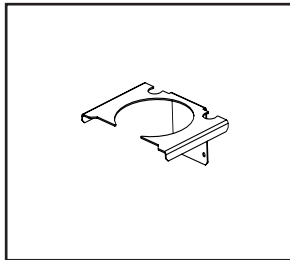

Position 5

**Bumper Cart_
Bowl Plate**

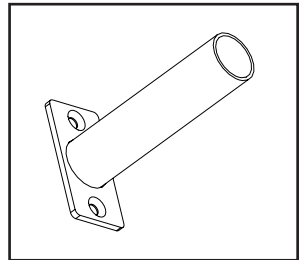

Position 7

**Reverse Hyper_
Bumper Stacker ZN**

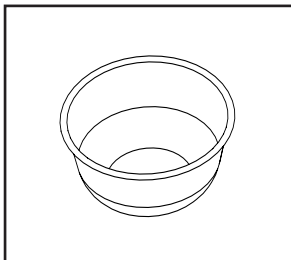

Position 8

Chalk Bowl Inox Raw

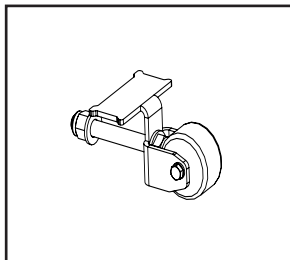

Position 9

SX Wheels S

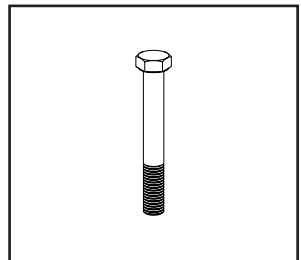

Position 10

M12x90

Assembly elements:

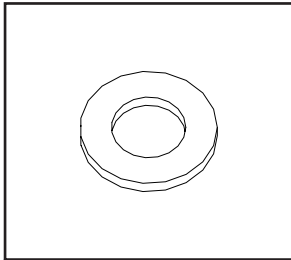

Position 11

M12 Washer

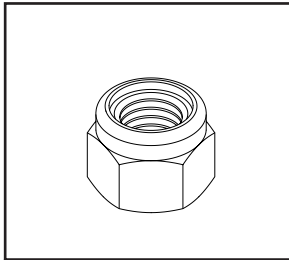

Position 12

M12 Nut

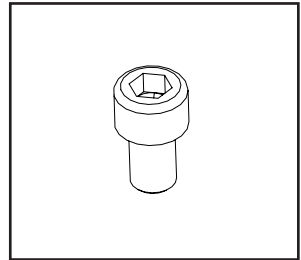

Position

Imbus M10x40

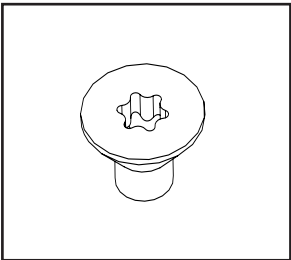

Position

Imbus M10x16

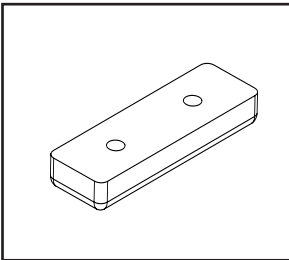

Position

Rubberized Mat

Assembly instruction:

STEP: 3

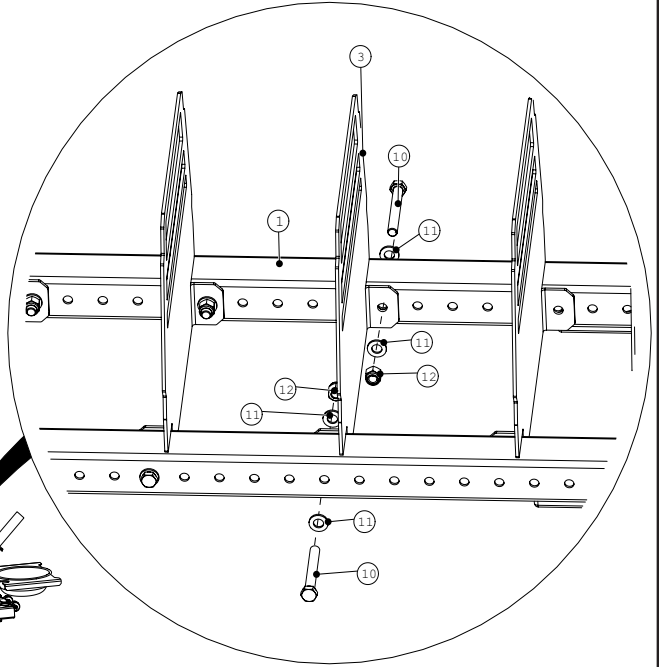
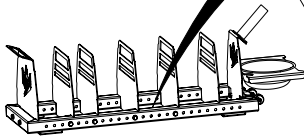

STEP: 4

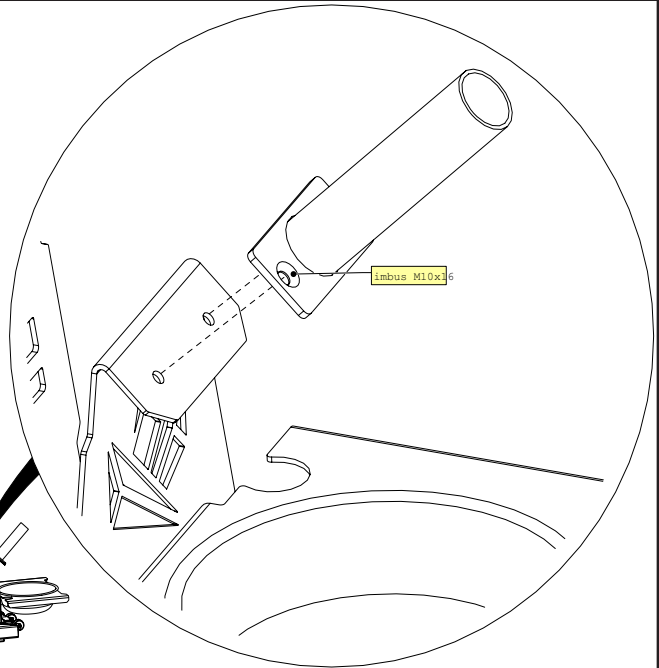
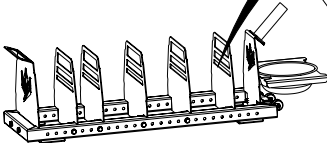

Assembly instruction:

STEP: 5

