

Bumper S Wall Storage

(KB08RI-088)

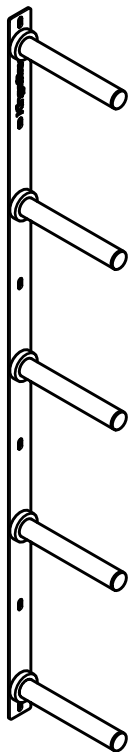

Manufacturer:

Kingsbox d.o.o.
Partizanska 129, 6210 Sežana
Slovenia

Customer service:

Write us on ***info@kingsbox.com*** or send us a message through our website at ***www.kingsbox.com/help***

Usage class:

Studio (S)

Designed in compliance with:

ISO 20957

Warnings:

- Freestanding equipment shall be installed on a stable and levelled base
- All equipment designed with anchoring/attachement holes (e.g. rigs, racks, equipment and accessories for racks, storage pins/shelves, etc.) should be securely screwed to the fixed ground/wall/rack structure through all the designated fixing holes and with appropriate sized screws.
- Injuries to health may result from incorrect or excessive training
- Keep unsupervised children away from the equipment

Maximum mass on storage pins: 70 kg/pin

ATTENZIONE!

Se la struttura non viene fissata a terra e/o al muro, può rib-altarsi e/o provocare danni a persone o oggetti in immediata vicinanza.

I bulloni per il fissaggio del rig a muro e/o al pavimento non sono inclusi nel pacco, in quanto per diversi tipi di muro e pavimentazione bisogna utilizzare diversi tipi di bulloni d'ancoraggio.

OPOZORILO!

Če se struktura prevrne, lahko pride do resnih telesnih poškodb. Da bi preprečili nevarnost, da se ta struktura prevrne, mora biti pritrjena na steno in / ali v tla.

Vijaki za pritrjevanje strukture na steno oz. tla niso priloženi, saj različne sestave zidov oz. tal zahtevajo različne vrste pritrdilnih elementov. Uporabite take, ki ustrezajo sestavi vaše stene oz. tal.

WARNING!

If the structure is not secured to the ground and / or to the wall, it may overturn and / or cause damage to person or object in the immediate vicinity.

The fixing bolts for wall and / or floor are not included in the pack-age, since different types of anchor bolts must be used for different wall / floor types.

Assembly elements:

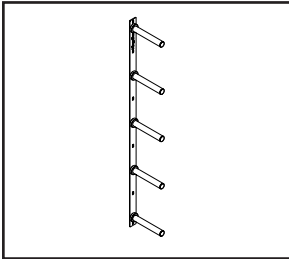

Position 1

**1x Bumper S Wall
Storage**

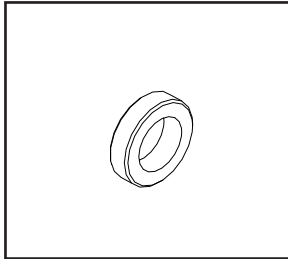

Position 2

**5x Spacer fi48
Rubberry**

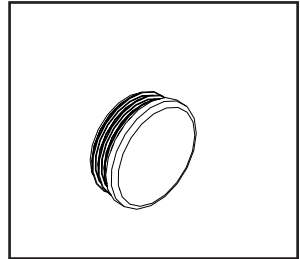

Position 3

5x Plug fi P1,5

Assembly instruction:

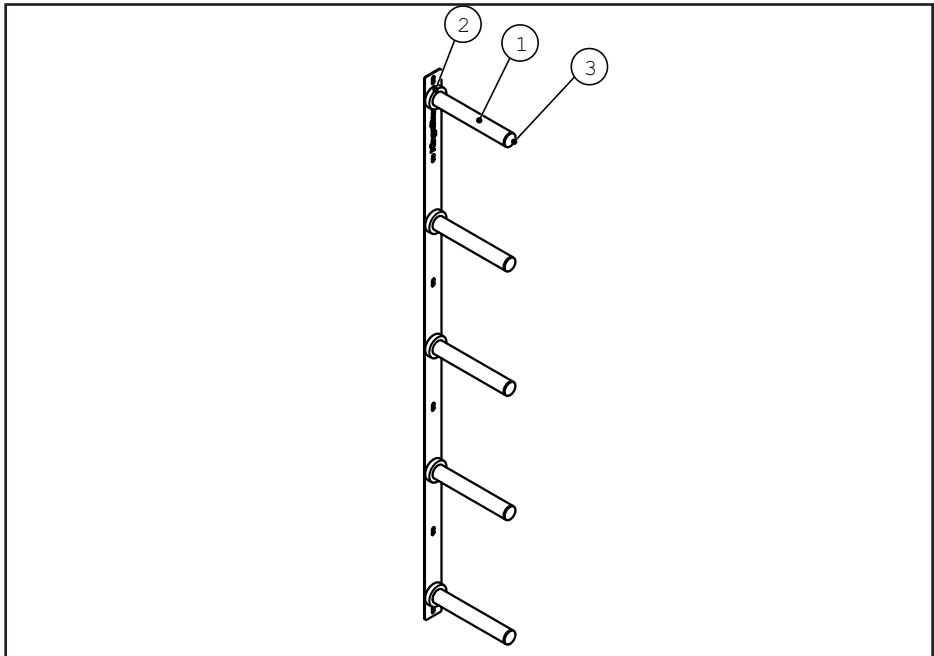

Mounting on the wall:

To be mounted with 6x M12 wall anchor screws. Bumper 3 Wall Storage kit does not include screws for fixation on the wall. For correct installation on your type of wall, please consult with a technician in a construction material store.

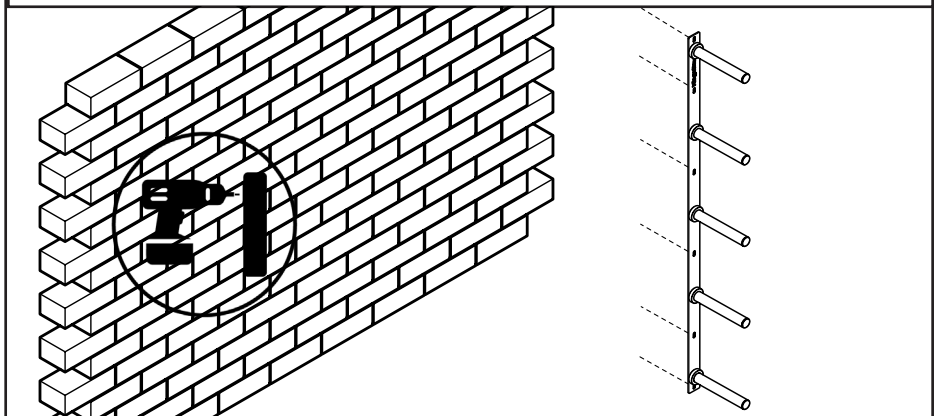

Assembly instruction:

Max. load:

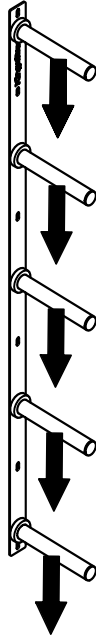

Max. load:
70 kg/pin