

Handles Storage High

(KB08RI-091 / KB08MI-014)

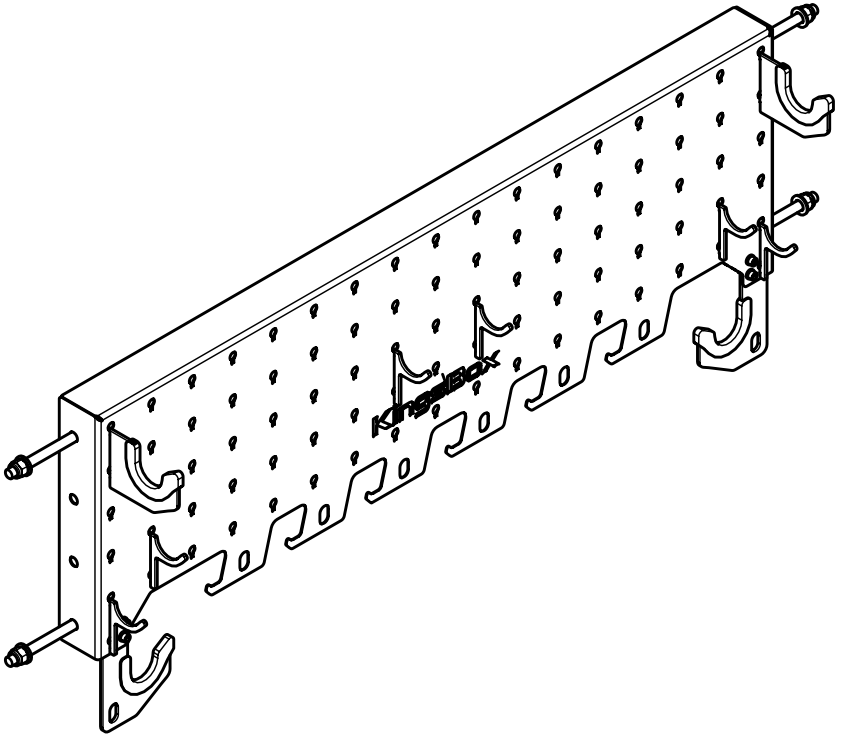

KingsBox®

BUILDING BETTER HUMANS

Manufacturer:
Kingsbox d.o.o.
Bazoviška 7a, 6210 Sežana
Slovenia

Customer service:

Write us on ***info@kingsbox.com*** or send us a message through our website at ***www.kingsbox.com/help***

Usage class:
Studio (S)

Designed in compliance with:
ISO 20957

Warnings:

- Freestanding equipment shall be installed on a stable and levelled base
- All equipment designed with anchoring/attachement holes (e.g. rigs, racks, equipment and accessories for racks, storage pins/shelves, etc.) should be securely screwed to the fixed ground/wall/structure through all the designated fixing holes (unless stated differently in this instructions for use) and with appropriate sized screws.
- Keep unsupervised children away from the equipment

This equipment is designed for storing training equipment, especially accessories for pulley systems (handles, pull down bars, etc.).

Maximum SUM mass on storage: 40kg
Maximum mass per hook: see page 8

ATTENZIONE!

Se la struttura non viene fissata a terra e/o al muro, può rib-altarsi e/o provocare danni a persone o oggetti in immediata vicinanza.

I bulloni per il fissaggio del rig a muro e/o al pavimento non sono inclusi nel pacco, in quanto per diversi tipi di muro e pavimentazione bisogna utilizzare diversi tipi di bulloni d'ancoraggio.

OPOZORILO!

Če se struktura prevrne, lahko pride do resnih telesnih poškodb. Da bi preprečili nevarnost, da se ta struktura prevrne, mora biti pritrjena na steno in / ali v tla.

Vijaki za pritrjevanje strukture na steno oz. tla niso priloženi, saj različne sestave zidov oz. tal zahtevajo različne vrste pritrdilnih elementov. Uporabite take, ki ustrezajo sestavi vaše stene oz. tal.

WARNING!

If the structure is not secured to the ground and / or to the wall, it may overturn and / or cause damage to person or object in the immediate vicinity.

The fixing bolts for wall and / or floor are not included in the pack-age, since different types of anchor bolts must be used for different wall / floor types.

Assembly elements:

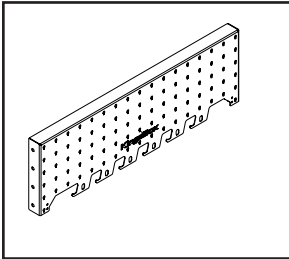

Position 1

1x Handles Storage High

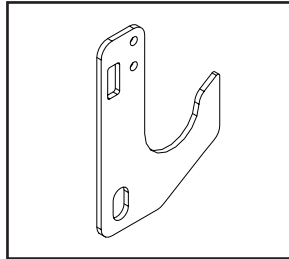

Position 2

2x Hook 1

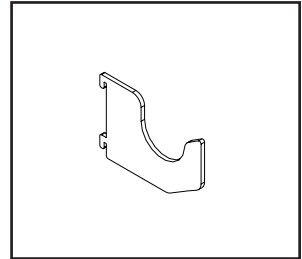

Position 3

2x Hook 2

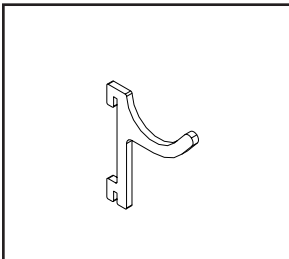

Position 4

6x Hook 3

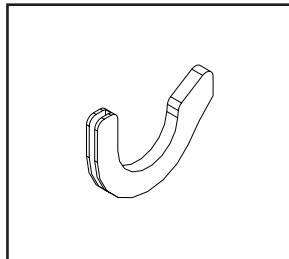

Position 5

4x Hook Protection

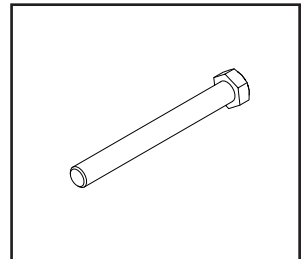

Position 6

**4x Screw M12x110
or M12x90**

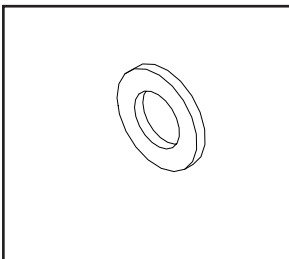

Position 7

8x Washer M6

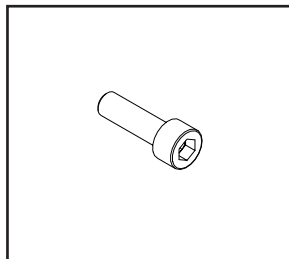

Position 8

4x Screw M6x20

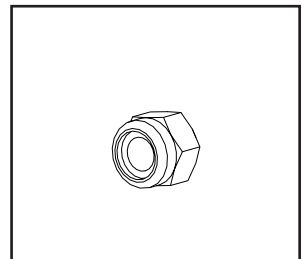

Position 9

4x Nut M6

Assembly elements:

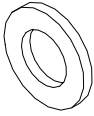

Position 10

8x Washer M12

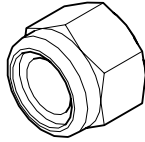

Position 11

4x Nut M12

Tools needed:

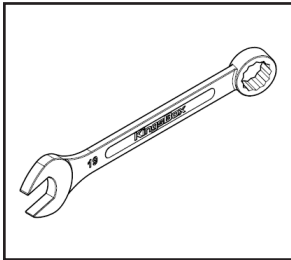

Wrench 19

2X

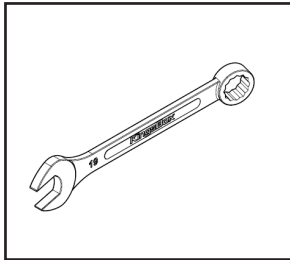

Wrench 10

2x

Assembly instruction:

STEP: 1

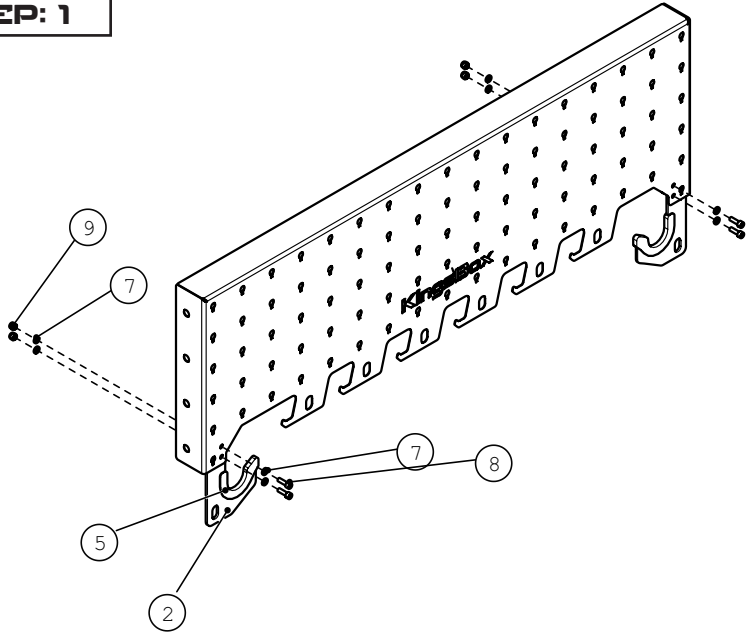

STEP: 2

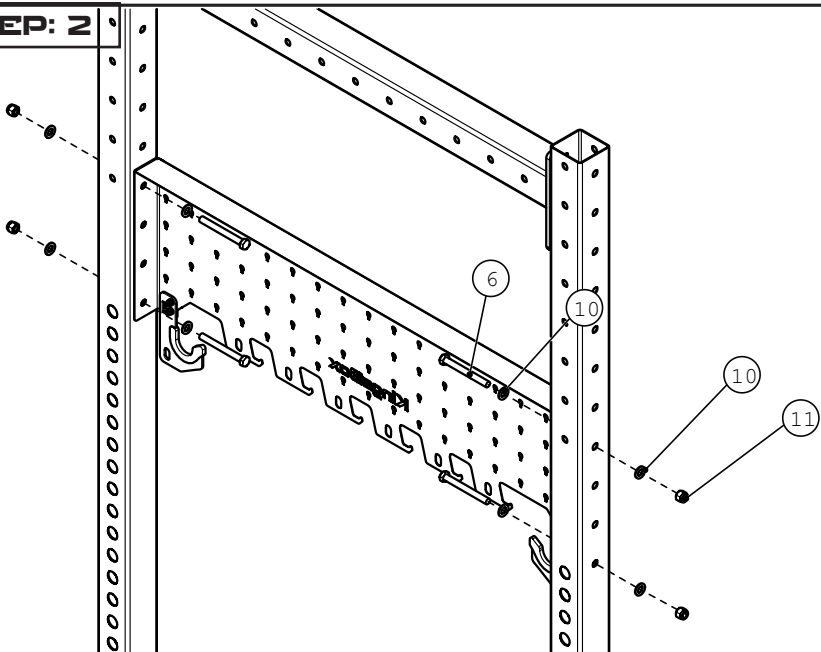

Assembly instruction:

STEP: 3

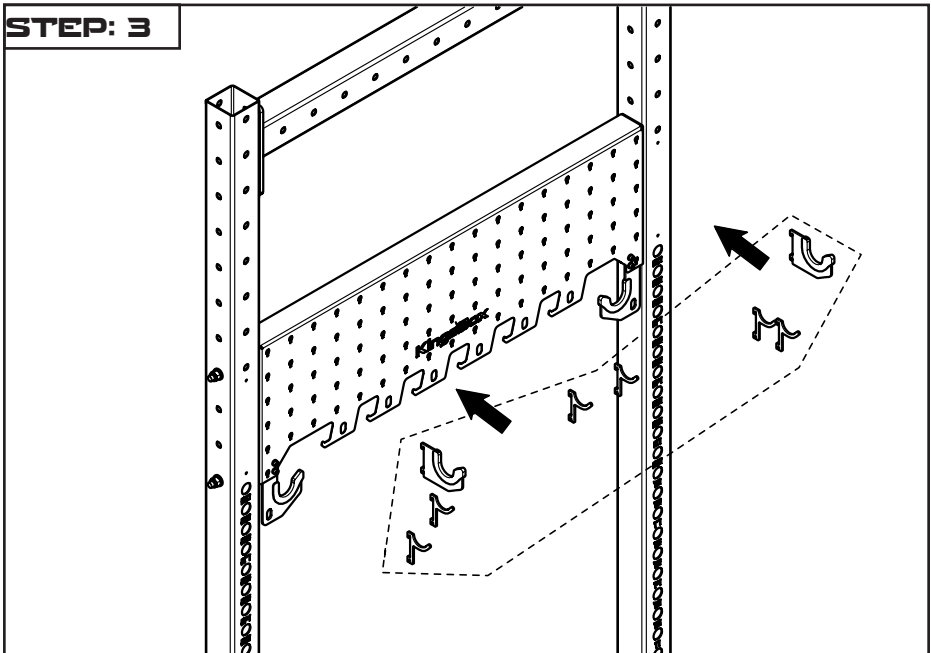

MAX. LOAD:

