

# 3 Shelf Multi Storage

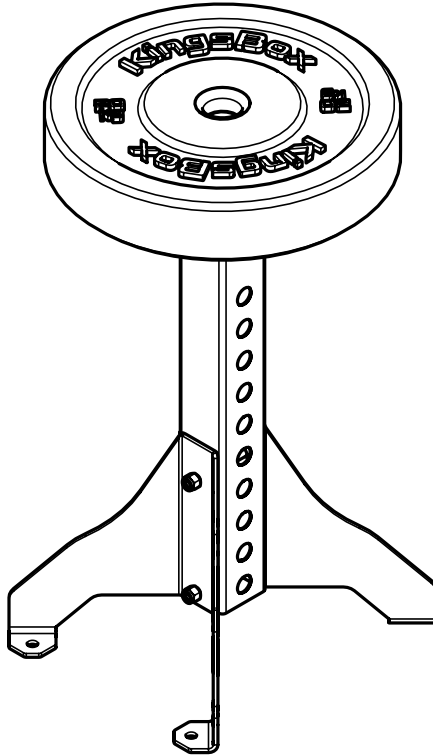

**KingsBox®**  
BUILDING BETTER HUMANS

## **ATTENZIONE!**

**Se la struttura non viene fissata a terra e/o al muro, può rib-altarsi e/o provocare danni a persone o oggetti in immediata vicinanza.**

I bulloni per il fissaggio del rig a muro e/o al pavimento non sono inclusi nel pacco, in quanto per diversi tipi di muro e pavimentazione bisogna utilizzare diversi tipi di bulloni d'ancoraggio.

---

## **OPOZORILO!**

**Če se struktura prevrne, lahko pride do resnih telesnih poškodb. Da bi preprečili nevarnost, da se ta struktura prevrne, mora biti pritrjena na steno in / ali v tla.**

Vijaki za pritrjevanje strukture na steno oz. tla niso priloženi, saj različne sestave zidov oz. tal zahtevajo različne vrste pritrdilnih elementov. Uporabite take, ki ustrezajo sestavi vaše stene oz. tal.

---

## **WARNING!**

**If the structure is not secured to the ground and / or to the wall, it may overturn and / or cause damage to person or object in the immediate vicinity.**

The fixing bolts for wall and / or floor are not included in the pack-age, since different types of anchor bolts must be used for different wall / floor types.

# Assembly elements:

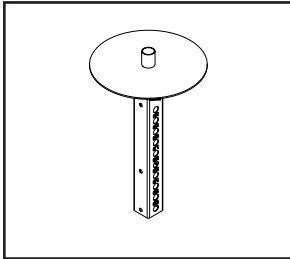

**Position 1**

**Stol za Fibo**

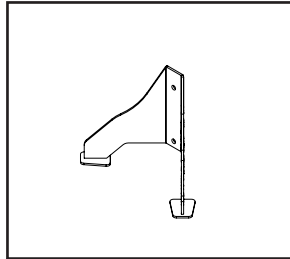

**Position 2**

**Chalk Stand Leg**

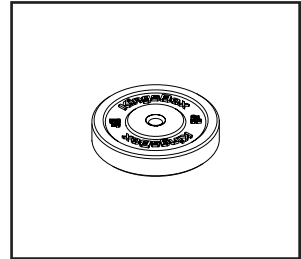

**Position 3**

**Bumper 20 kg**

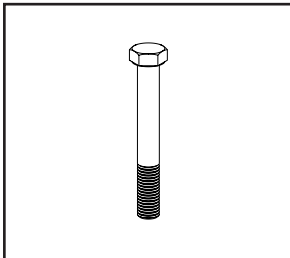

**Position 4**

**M12x110**

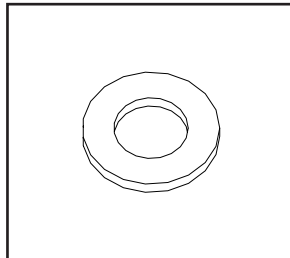

**Position 5**

**M12 Washer**

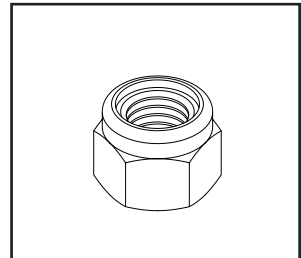

**Position 6**

**M12 Nuts**

# Assembly instruction:

**STEP: 1**

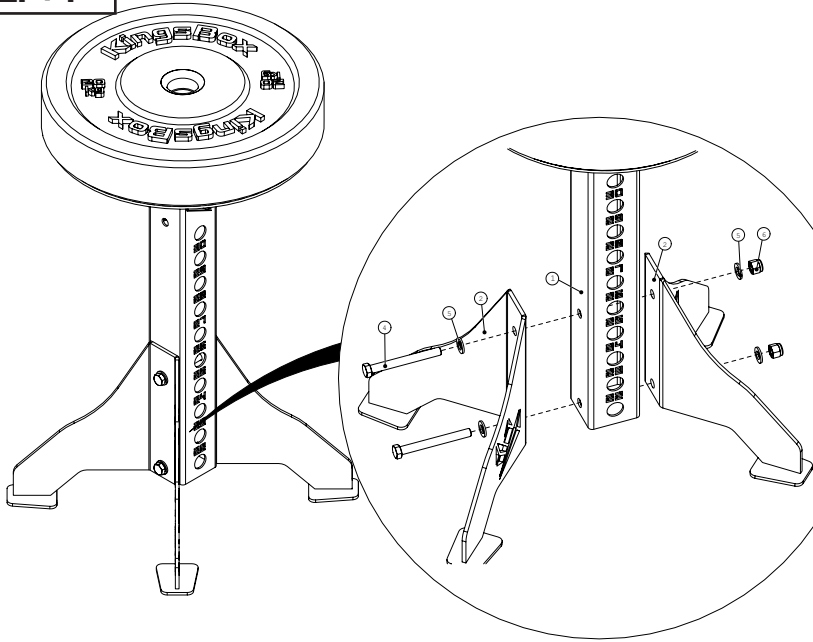

**STEP: 2**

