

Pulley Rig CX-30

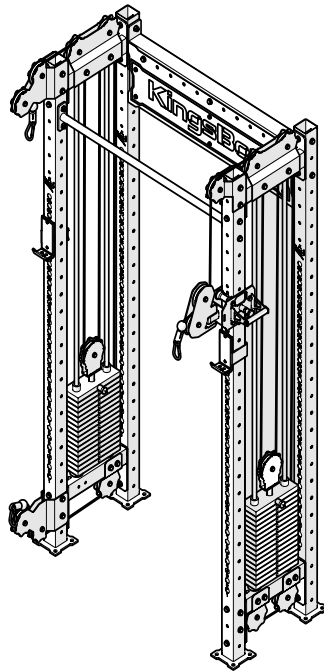

KingsBox®
BUILDING BETTER HUMANS

ATTENZIONE!

Se la struttura non viene fissata a terra e/o al muro, può rib-altarsi e/o provocare danni a persone o oggetti in immediata vicinanza.

I bulloni per il fissaggio del rig a muro e/o al pavimento non sono inclusi nel pacco, in quanto per diversi tipi di muro e pavimentazione bisogna utilizzare diversi tipi di bulloni d'ancoraggio.

OPOZORILO!

Če se struktura prevrne, lahko pride do resnih telesnih poškodb. Da bi preprečili nevarnost, da se ta struktura prevrne, mora biti pritrjena na steno in / ali v tla.

Vijaki za pritrjevanje strukture na steno oz. tla niso priloženi, saj različne sestave zidov oz. tal zahtevajo različne vrste pritrdilnih elementov. Uporabite take, ki ustrezajo sestavi vaše stene oz. tal.

WARNING!

If the structure is not secured to the ground and / or to the wall, it may overturn and / or cause damage to person or object in the immediate vicinity.

The fixing bolts for wall and / or floor are not included in the pack-age, since different types of anchor bolts must be used for different wall / floor types.

Assembly elements:

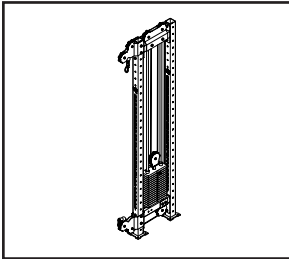

Position 1

**Static or Adjustable
Pulley Rig**

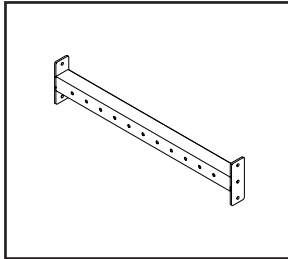

Position 2

Monkey Profile 1100

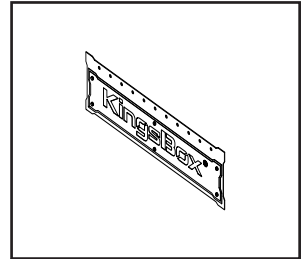

Position 3

**KingsBox Manifest
Sign**

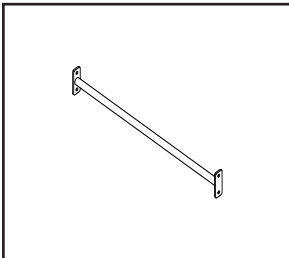

Position 4

Pull Up Bar 1100

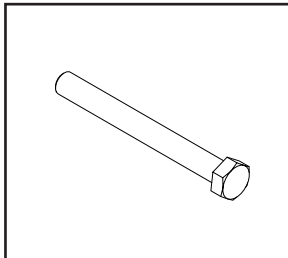

Position 6

M12x1100

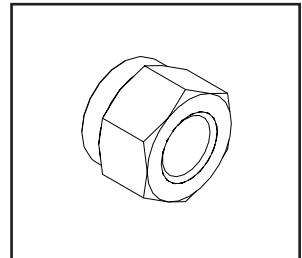

Position 7

Nut M12

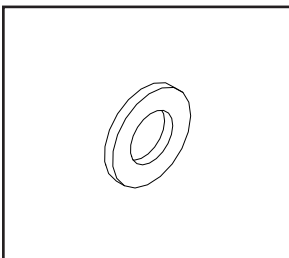

Position 8

Washer M12

Assembly instruction:

STEP: 1

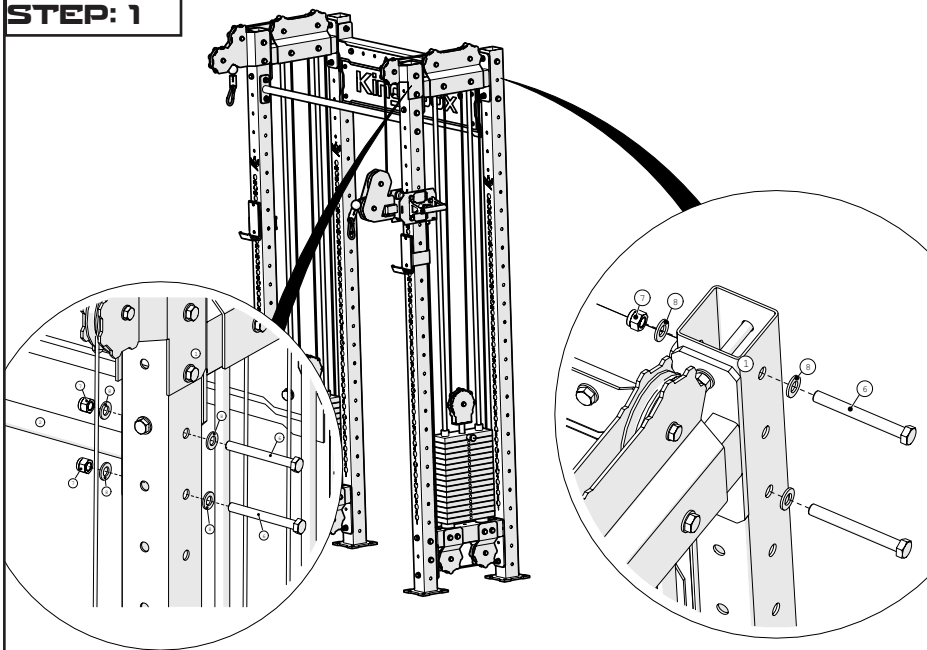

STEP: 2

